

Axiaalventilatoren

Helios
PIONAIRS
SINCE 1923



T 0320 - 28 61 81 | www.auerhaan-klimaattechnik.nl

Als het om lucht gaat.

**AUERHAAN**
KLIMAATTECHNIEK

Competence in aerodynamics. Axial fans without limits.



As a leading European fan manufacturer, Helios offers an exceptional, finely tuned series range of high performance and medium pressure axial fans and RADAX® VAR high pressure round duct fans in all performance ranges.

The series range of high performance axial fans with aerodynamically and acoustically optimised impellers and innovative motor concepts (Ø 250 to 500 mm) is presented on the following pages.

The especially **energy-saving EC models** with speed control achieve energy savings of more than 55% in comparison to conventional AC types.

Voltage controllable high performance axial AC fans in Ø 250 to 500 mm are characterised by their proven robust design and a 25% increase in efficiency with 50% noise reduction.

The series range with Ø up to 1000 mm is complemented by technical building equipment (TGA) solutions.

- Fire gas and smoke extraction types according to DIN 12101-3 in temperature classes F300 (60 min.), F400 (120 min.) and F600 (120 min.).
See TGA catalogue, Ref. no. 86979.
- Special technical building equipment (TGA) solutions and large axial fans from Ø 1000 to 7100 mm, V up to 2.2 million m³/h, are manufactured according to customer-specific requirements.

Renowned users rely on the application of Helios axial fans in ventilation, heating, cooling, air conditioning and drying systems around the world.

The large fans have been used successfully for decades, e.g. in cooling towers and air coolers.

■ High performance axial fans

Energy-efficient EC version.

Ø 250 – 710 mm
 V = 1970 – 19 400 m³/h

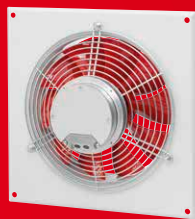

182^f

■ High performance axial fans

Standard AC version.

Ø 200 – 1000 mm
 V = 520 – 63 420 m³/h



Also available in version:



200^f

■ High performance axial fans

Product-specific information, selection table.

180^f

Axial and VAR fans

■ Medium pressure axial fans

Product-specific information, selection table.

Ø 225 – 630 mm
 V = 950 – 32 000 m³/h



226^f

■ RADAX® VAR high pressure fans

Product-specific information, selection table.

Ø 225 – 630 mm
 V = 900 – 22 310 m³/h



Also available in version:



252^f

■ Installation accessories

For axial fans and VAR fans.

276^f

This information supplements the "General technical information".

■ Designs

- Standard and high performance fans in industrial design are manufactured in series with more than 20 nominal sizes and more than 1000 types.
- A closely graduated range up to impeller Ø 7100 mm in various designs is available for higher volume and pressure rates. Four different versions are available as standard.
- Types HQ, HW and HRF up to nominal size 500 mm with highly efficient EC drive technology are optionally available for especially energy-efficient applications and minimal operating costs.

■ Versions in this catalogue

1. Wall fan HQ

Square plate with intake nozzle

Casing made of galvanised steel sheet. Motor with terminal box and protection grille on inlet side.

2. Built-in fans

HW, AVD DK

Wall ring with intake nozzle

Casing made of galvanised steel sheet. Motor with terminal box and protection grille on inlet side.

3. Built-in wall fan HS

Pipe sleeve, cylindrical with smooth ends

For flush-mounted wall or duct installation. Casing made of galvanised steel sheet with circumferential reinforcing beads.

4. Round duct fans

HRF, AVD RK

Pipe sleeve, with double-sided flanges

For direct intermediate flanges in pipeline. Flange in accordance with DIN 24155, p. 3. Casing made of galvanised steel sheet, with additional terminal box (IP55) on outside of duct.

■ Drive

AC types

Robust 1~ or 3~ internal rotor motors with thermal contacts in the winding. Ball bearings with lifetime lubrication.

EC types

Highly efficient, speed-controllable external rotor motors in protection category IP54. Ball bearings with lifetime lubrication.

■ Impellers

- Depending on requirements, the impellers are made of different materials; see information on the product pages. The standard versions are made of plastic, but other materials e.g. aluminium or steel are possible according to requirements.

Common features:

- Low operating noise level.
- High level of efficiency.
- Vibration-free running due to dynamic balancing in accordance with DIN ISO 21940-11 – quality grade 6.3.
- Impellers made of other materials are possible upon request.
- Impellers made of metal are available at an extra charge for higher temperatures. The information on the product pages is decisive.

■ Angle of attack

- The series products up to 630 mm Ø are equipped with fixed impellers.
- The blades can be delivered with order-based angles of attack from nominal size 710 mm upwards (except for type HQW 710/6).
- The sizes Ø 800/4, 900/4 and/6 as well as Ø 1000 mm have blades which can be adjusted at standstill. This allows optimal coverage of the operating point. The angle of attack is adjusted (according to the order) and fixed in the factory. The motor is assigned using the maximum power (see table). The specified angle of attack must not be exceeded, otherwise the motor can be overloaded.

■ Contact protection

With regard to installation and operation, The applicable occupational safety and accident protection guidelines as well as contact protection according to VDE 0700 or DIN EN ISO 13857 must be observed. Contact with rotating parts must be prevented. It must be ensured that there are no loose substances in the intake area. Fans which are protected by their installation type (e.g. installation in ventilation duct or closed aggregates) do not require a protection grille if the system provides sufficient safety. Please note that the installer can be held liable for accidents as the result of the lack of protection devices. Suitable protection grilles are available as accessories. The installer and operator shall be responsible for observing safety regulations.

Air flow direction

All fans (except for HRF and AVD RK) are designed with air flow direction
A = inlet over motor
B = outlet over motor
 can be delivered for most types upon request (at an extra charge).
 HRF and AVD RK are delivered with air flow direction B as standard.

- The subsequent conversion of air flow direction is possible for most high performance axial AC fans. This requires the following:
 1. Change of direction of motor rotation by reversing the polarity on the terminal board.
 2. Removal of the impeller and reattachment the other way round (possible up to Ø 500). A performance reduction of approx. 1/3 should be expected for series HQ and HW.
- EC types can only be operated in the standard direction of rotation.

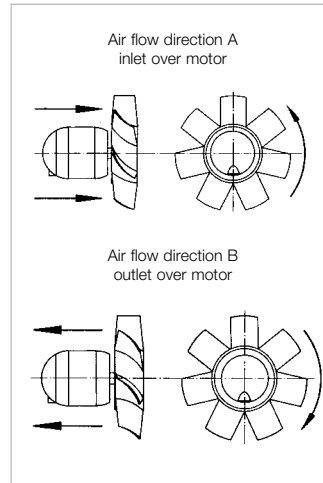

■ Installation position, installation, condensate outlets

- Axial fans can be installed and operated in any position in compliance with the permissible protection category (see product page). In case of equipment with condensate drain holes, please be aware of their position.
- In case of outdoor installation, installation in permanently humid or wet environments or in case of installation with a vertical shaft, this must be indicated when placing the order, because a special design may be required. The installation site and mounting should be such that the fan can be mounted securely and without warping.

■ Reverse operation

- Most high performance axial AC fans (see product pages) are reversible. Either supply or extract ventilation can take place using a suitable reverser switch. There is a performance reduction of approx. 1/3 in an abnormal flow direction.
- The EC types are non-reversible as standard.

■ Air flow temperatures

Temporarily higher air flow temperatures are also possible with the exception of explosion-proof versions. Versions designed for higher continuous temperatures

are possible in the area of custom production.

■ Motor protection

- Through built-in thermal contacts in the winding for AC types
 - standard for 1~ motors,
 - mostly standard for 3~ motors (see product page).
- Integrated electronic temperature monitoring system for EC types.
- The regulations DIN EN 60079-10 shall apply for explosion-proof types. According to this, overload protection must be provided for each fan by a motor protection circuit breaker, which must be triggered within the heating time specified in the test certificate in case of a short circuit. Fans must be protected by a protection grille or shutter against foreign bodies larger than 12 mm getting sucked in or falling in. Approved operating mode according to DIN EN 60034-1/VDE 0530 = S1 (continuous operation). Speed control is not permitted.

■ Explosion protection

The explosion-proof types correspond to unit group II, category 2G for operation in zone 1 and 2. Larger air gaps which result in a performance reduction of approx. 10% are stipulated in accordance with Directive 2014/34/EU (ATEX).

■ Special equipment, Additional costs upon request

- Impeller made of die-cast aluminium**
- Deviating voltage**
- Deviating frequency**
- Two-component lacquer coating (RAL 6011)** to protect the external unit parts against weak acids and alkaline solutions
- Deviating air flow direction**
- Special equipment for higher air flow temperatures**
- Pressure-resistant encapsulated motors (standard for 1~ explosion-proof types)**

■ Vibration insulation

The use of vibration dampers (accessories SDD, SDZ) is recommended to prevent vibration transmission. Larger motors may protrude from the back and cause uneven distribution due to their high weight. An extension duct VR (accessories) should be provided to adjust the centre of gravity.

By combining the parameters of static pressure increase Δp_{ia} , flow rate V , speed min^{-1} , sound pressure level dB(A) and impeller diameter DN mm, the following table facilitates the selection of high performance

axial EC fans \varnothing 250 to 710 mm and high performance axial fans \varnothing 200 to 1000 mm.

	Speed	Sound pressure inlet side L_{PA} dB(A) at 4 m distance	Flow rate V m ³ /h depending on static pressure																
			(Δp_{ia}) in Pa																
			0	10	20	30	40	50	60	80	100	120	140	160	200	250	300	350	400
EC 250 A	2710	58	1970	1940	1900	1820	1790	1750	1680	1540	1330	1120	760						
EC 315 A	1920	52	2780	2740	2690	2600	2510	2420	2330	2160	1800								
EC 355 A	1460	49	2990	2910	2660	2490	2410	2240	2070										
EC 355 B	1975	59	4200	4150	4090	4020	3960	3890	3820	3690	3540	3360	3100	2790					
EC 400 A	1800	59	4790	4690	4610	4540	4460	4390	4310	4140	3920	3640	3240						
EC 400 B	2150	65	5850	5800	5760	5700	5640	5560	5490	5360	5210	5080	4870	4730	4030				
EC 450 A	1325	55	5460	5350	5250	5140	5030	4910	4790	4520	4200	3730							
EC 450 B	1835	64	7640	7580	7510	7450	7390	7330	7260	7070	6880	6680	6490	6200	5530				
EC 500 A	1025	54	6320	6190	6050	5900	5750	5590	5420	5010	4460								
EC 500 B	1450	62	8300	8230	8150	8070	7970	7880	7790	7490	7300	6910	6530	6140					
EC 560	1200	55	9740	9550	9360	9160	8780	8590	8400	8020	7440	6480							
EC 630	960	54	10330	10100	9860	9630	9400	8930	8700	7770	6370								
EC 710	1100	61	19400	18920	18440	18210	17970	17490	17240	16530	15570	14610	13650	11260					

\varnothing in mm	Speed	Sound pressure inlet side L_{PA} dB(A) at 4 m distance	Flow rate V m ³ /h depending on static pressure																
			(Δp_{ia}) in Pa																
			0	10	20	30	40	50	60	80	100	120	140	160	200	250	300	350	400
200	2300	55	910	860	810	760	710	490	420	330	220								
200	1360	42	520	410	210	170													
250	2800	53	2070	2040	2010	1970	1940	1910	1870	1800	1710	1610	1480						
250	1450	44	930	840	730														
250	950	31	660	570															
315	2800	69	4090	4050	4020	3990	3950	3920	3880	3790	3700	3610	3500	3380	3090				
315	1450	51	2090	2010	1930	1840	1740	1620	1410										
315	950	38	1330	1220	1070														
315	725	30	980	780															
355	2800	71	5710	5670	5620	5580	5530	5480	5430	5330	5220	5110	4990	4860	4550	4020			
355	1450	51	2850	2770	2670	2570	2450	2320	2160										
355	950	42	1940	1830	1690	1500	1060												
355	725	34	1430	1240	880														
400	2800	71	8410	8360	8310	8270	8220	8170	8130	8030	7940	7840	7750	7650	7440	7160	6840	6440	5820
400	1450	56	4010	3920	3810	3700	3580	3440	3300	2970									
400	950	45	2570	2410	2230	2020													
400	725	37	2010	1810	1530														
450	2800	78	11050	10960	10870	10770	10680	10590	10500	10310	10130	9950	9770	9580	9210	8690	8050	6930	4520
450	1450	58	5770	5680	5590	5500	5390	5280	5160	4870	4510	4010							
450	950	47	3890	3720	3550	3360	3150	2890											
450	725	51	2860	2680	2450	2120													
500	2800	81	13150	13040	12930	12820	12720	12610	12500	12290	12070	11860	11660	11440	11010	10380	9600	8620	5390
500	1450	65	8320	8220	8110	8000	7880	7760	7630	7370	7080	6760	6400	5970					
500	950	51	5500	5330	5140	4950	4740	4510	4240	3450									
500	725	44	3890	3690	3440	3150	2750												
560	1450	62	12910	12680	12550	12360	12140	11950	11770	11320	10900	10550	10000	9500	8270				
560	950	52	8100	7680	7370	7080	6680	6280	5830	4570									
560	725	46	6450	6070	5640	5230	4750	4140											
630	1450	65	17870	17650	17420	17200	16970	16750	16520	16010	15500	15000	14500	14000	13000	11300			
630	950	55	10520	10150	9780	9410	9040	8670	8220	7260									
630	725	49	8000	7580	7010	6530	5910	5300											
710	1450	71	23740	23490	23240	22980	22730	22470	22200	21660	21090	20500	19900	19290	18010	16240	14000	11060	
710	935	61	15250	14860	14450	14040	13590	13140	12600	11690	10610	9280	7440						
710	700	54	11350	10810	10250	9630	8990	8300	7500	5340									
800	1435	73	32350	32040	31720	31400	31090	30770	30490	29860	29230	28610	27990	27330	25940	24020	22080		
800	945	62	20720	20280	19830	19350	18850	18290	17710	16530	15330	13840	10740						
800	705	55	15380	14780	14120	13380	12580	11790	10900										
900	1435	76	46060	45700	45390	45030	44670	44310	44000	43280	42600	41880	41170	40800	39060	37110	34940	32800	30340
900	950	66	30500	30100	29500	29100	28500	27900	27400	26300	25100	23910	22710	21310					
900	725	59	21160	20410	19640	18850	18010	17120	16130	15000									
1000	1440	80	63420	63030	62650	62260	61870	61490	61110	60330	59560	58790	58010	57240	55700	53710	51590	49260	46830
1000	950	69	41740	41150	40570	39990	39400	38810	38230	37060	35870	34610	33260	31810	28880				
1000	725	62	31760	30990	30220	29460	28690	27930	27130	25410	23500	21540							

Axial and VAR fans

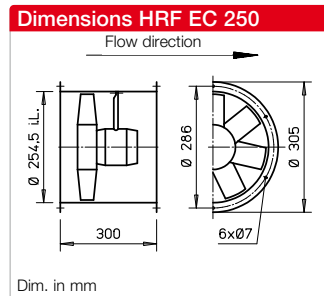
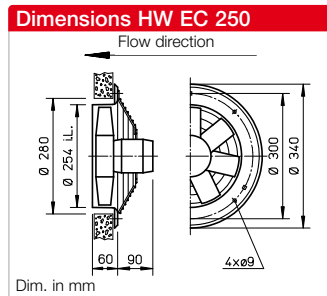
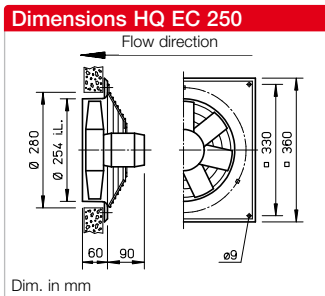

Description for all types

■ **Casing**

Made of galvanised steel sheet, types HQ and HW have additional two layer lacquer coating in papyrus white.

■ **Impeller**

High performance characteristics with profiled blades made of plastic, aerodynamically optimised for application, dynamically balanced.

■ **Drive**

Energy-saving, speed-controllable external rotor EC motor in protection category IP54 with the highest level of efficiency. Maintenance-free and radio interference-free, excellent electromagnetic compatibility (EMC), ball bearing mounted.

■ **Motor protection**

Integrated electronic temperature monitoring system for EC motor and electronics.

■ **Electrical connection**

Standard terminal box (protection category IP54) mounted to external cable, or on outside of duct for HRF.

■ **Protection grille**

Made of powder-coated steel for HQ and HW in accordance with DIN EN ISO 13857.

■ **Power control**

All types are continuously controllable via internal (delivery) or external speed potentiometer. Control is also possible via three level switch or continuously variable via universal control system or electronic differential pressure/temperature controller. See type table. Performance levels are shown on the performance curve as examples.

■ **Installation**

Installation possible in any position.

■ **Noise levels**

The total level and range for the sound power level and sound pressure level at 4 m free field conditions are specified above the performance diagram for the average operating point on the inlet/outlet side. The total sound pressure level at 4 m (free field conditions) is also specified in the type table, as well as the table below the performance diagram for various voltages. See page 14 f for noise emissions and room acoustics.

Speed	Flow rate-free-blowing	Power consump.	Current consump.	Sound pressure	Wiring diagram	Max. air flow temperature	Wgt net	Design type					
								HQ EC incl. protection grille	Ref. no.	HW EC incl. protection grille	Ref. no.	HRF EC	Ref. no.
min ⁻¹	V m ³ /h	kW	A	dB(A) at 4m	No.	+°C	ca. kg						
Alternating current, 1~, 230 Volt, 50/60 Hz, EC motor, protection category IP54													
2710	1970	0.13	0.97	58	1252	40	6.0	HQW EC 250 A	04822	HWW EC 250 A	04823	HRFW EC 250 A	04824

Performance curves HQ EC / HW EC / HRF EC 250 A

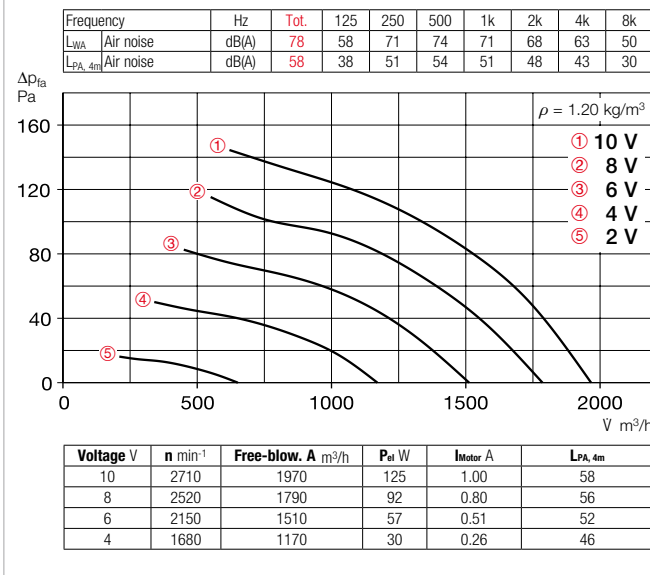

Accessories for HRF EC 250 Description see page 276 ff.

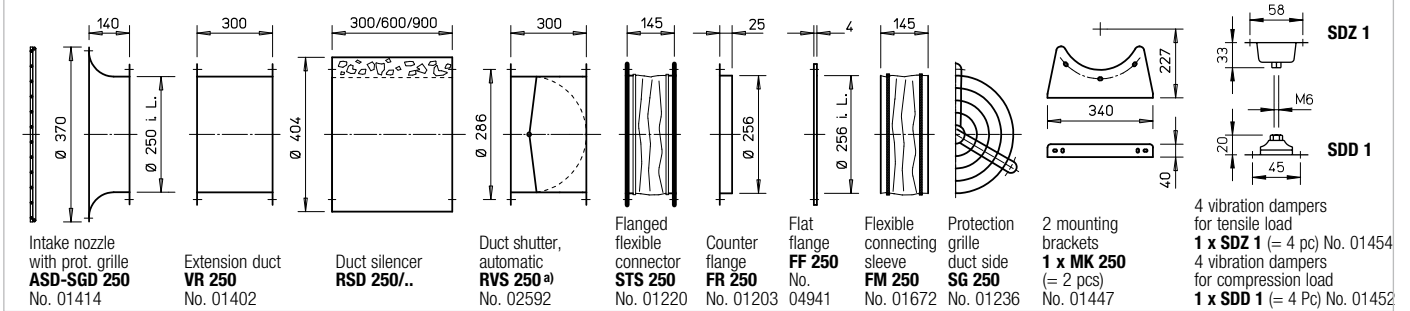

^{a)} Shutter, motorised see Accessories product pages.

References	Page
Techn. description	180
Selection table	181
Planning information	14 ff.

Special design
Different voltage, air flow direction, higher air flow temperature, acid protection upon request.

The technical information on p.19 ff. must be observed.

Other accessories	Page
Filters and silencers	481 ff.
Shutters and ventilation grilles	561 ff.
Universal control system, electronic controller, Speed potentiometer	613 ff.

Universal control system		Speed potentiometer		Three level speed switch		Electronic pressure difference controller/ actuator		Electronic temperature controller/actuator					
Type	Ref. no.	Type	Ref. no.	Type	Ref. no.	Type	Ref. no.	Type	Ref. no.				
EUR EC ¹⁾	01347	PU 10 ¹⁾	01734	PA 10 ¹⁾	01735	SU-3 10 ¹⁾	04266	SA-3 10 ¹⁾	04267	EDR ¹⁾	01437	ETR ¹⁾	01438

¹⁾ Multiple EC fans can normally be connected, see Accessories.

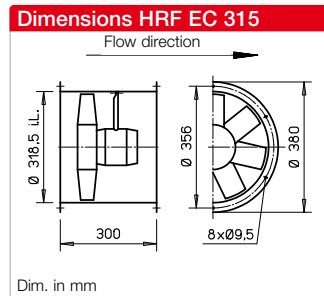
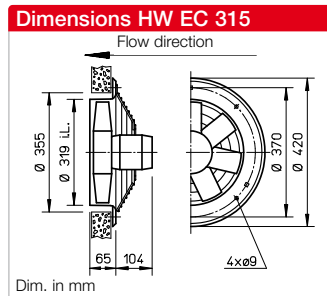
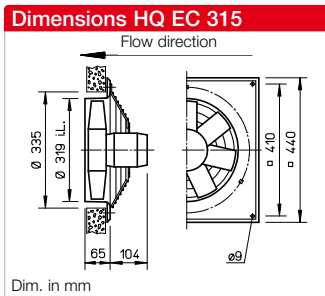

Description for all types

■ **Casing**

Made of galvanised steel sheet, types HQ and HW have additional two layer lacquer coating in papyrus white.

■ **Impeller**

High performance characteristics with profiled blades made of plastic, aerodynamically optimised for application, dynamically balanced.

■ **Drive**

Energy-saving, speed-controllable external rotor EC motor in protection category IP54 with the highest level of efficiency. Maintenance-free and radio interference-free, excellent electromagnetic compatibility (EMC), ball bearing mounted.

■ **Motor protection**

Integrated electronic temperature monitoring system for EC motor and electronics.

■ **Electrical connection**

Standard terminal box (protection category IP54) mounted to external cable, or on outside of duct for HRF.

■ **Protection grille**

Made of powder-coated steel for HQ and HW in accordance with DIN EN ISO 13857.

■ **Power control**

All types are continuously controllable via internal (delivery) or external speed potentiometer. Control is also possible via three level switch or continuously variable via universal control system or electronic differential pressure/temperature controller. See type table. Performance levels are shown on the performance curve as examples.

■ **Installation**

Installation possible in any position.

■ **Noise levels**

The total level and range for the sound power level and sound pressure level at 4 m free field conditions are specified above the performance diagram for the average operating point on the inlet/outlet side. The total sound pressure level at 4 m (free field conditions) is also specified in the type table, as well as the table below the performance diagram for various voltages. See page 14 f for noise emissions and room acoustics.

Speed	Flow rate-free-blowing	Power consump.	Current consump.	Sound pressure	Wiring diagram	Max. air flow temperature	Wgt net	Design type					
								HQ EC incl. protection grille	Ref. no.	HW EC incl. protection grille	Ref. no.	HRF EC	Ref. no.
min ⁻¹	V m ³ /h	kW	A	dB(A) at 4m	No.	+°C	ca. kg						
Alternating current, 1~, 230 Volt, 50/60 Hz, EC motor, protection category IP54													
1920	2780	0.15	1.20	52	1252	40	7.5	HQW EC 315 A	04880	HWW EC 315 A	04881	HRFW EC 315 A	04882

Performance curves HQ EC / HW EC / HRF EC 315 A

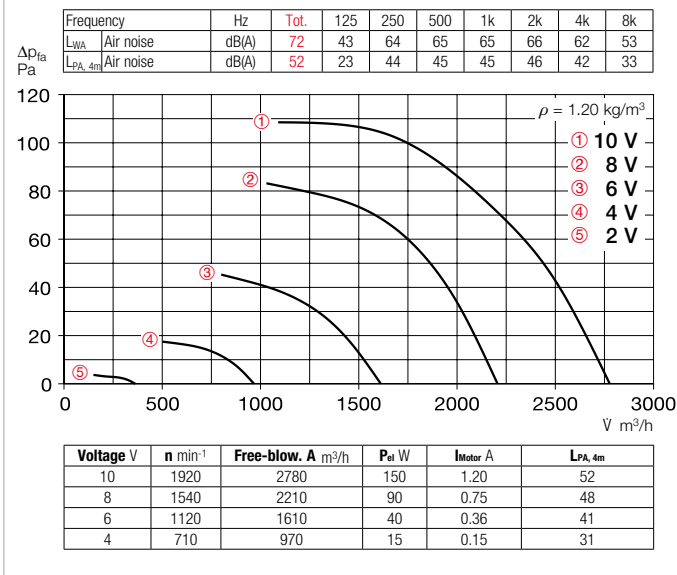

Accessories for HRF EC 315 Description see page 276 ff.

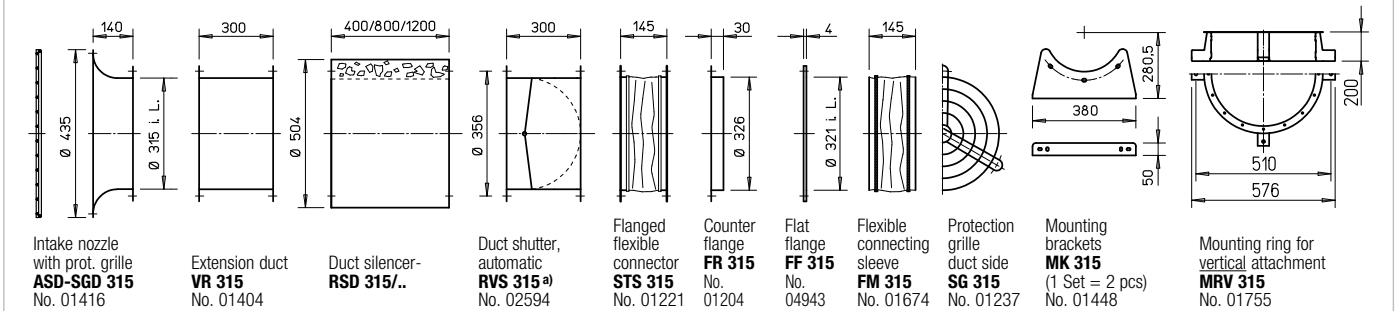

a) Shutter, motorised see Accessories product pages.

References	Page	Other accessories	Page
Techn. description	180	Filters and silencers	481 ff.
Selection table	181	Shutters and ventilation grilles	561 ff.
Planning information	14 ff.	Universal control system, electronic controller, Speed potentiometer	613 ff.

Special design
Different voltage, air flow direction, higher air flow temperature, acid protection upon request.

The technical information on p.19 ff. must be observed.

Universal control system		Speed potentiometer		Three level speed switch		Electronic pressure difference controller/ actuator		Electronic temperature controller/actuator					
Type	Ref. no.	Type	Ref. no.	Type	Ref. no.	Type	Ref. no.	Type	Ref. no.				
EUR EC ¹⁾	01347	PU 10 ¹⁾	01734	PA 10 ¹⁾	01735	SU-3 10 ¹⁾	04266	SA-3 10 ¹⁾	04267	EDR ¹⁾	01437	ETR ¹⁾	01438

1) Multiple EC fans can normally be connected, see Accessories.

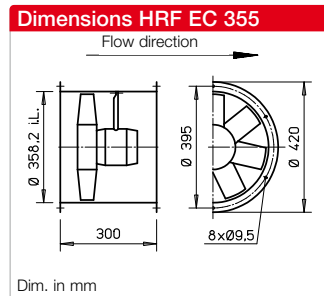
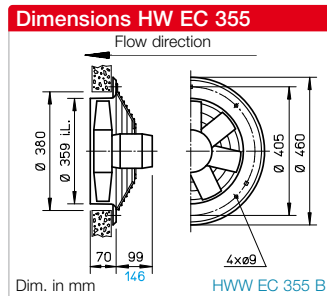
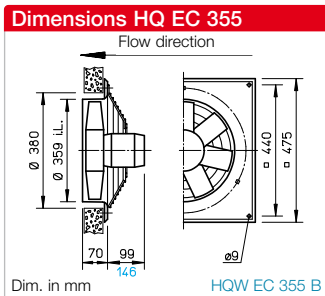

Description for all types

■ **Casing**

Made of galvanised steel sheet, types HQ and HW have additional two layer lacquer coating in papyrus white.

■ **Impeller**

High performance characteristics with profiled blades made of plastic, aerodynamically optimised for application, dynamically balanced.

■ **Drive**

Energy-saving, speed-controllable external rotor EC motor in protection category IP54 with the highest level of efficiency. Maintenance-free and radio interference-free, excellent electromagnetic compatibility (EMC), ball bearing mounted.

■ **Motor protection**

Integrated electronic temperature monitoring system for EC motor and electronics.

■ **Electrical connection**

Standard terminal box (protection category IP54). Mounted to external cable for HQ and HW types (version "A") or on back of motor (version "B"). Mounted on outside of duct for HRF types.

■ **Protection grille**

Made of powder-coated steel for HQ and HW in accordance with DIN EN ISO 13857.

■ **Power control**

All types are continuously controllable via internal (delivery) or external speed potentiometer. Control is also possible via three level switch or continuously variable via universal control system or electronic differential pressure/temperature controller. See type table. Performance levels are shown on the performance curve as examples.

■ **Installation**

Installation possible in any position.

■ **Noise levels**

The total level and range for the sound power level and sound pressure level at 4 m free field conditions are specified above the performance diagram for the average operating point on the inlet/outlet side. The total sound pressure level at 4 m (free field conditions) is also specified in the type table, as well as the table below the performance diagram for various voltages. See page 14 f for noise emissions and room acoustics.

Speed	Flow rate-free-blowing	Power consump.	Current consump.	Sound pressure	Wiring diagram	Max. air flow temperature	Wgt net	Design type					
								HQ EC incl. protection grille	Ref. no.	HW EC incl. protection grille	Ref. no.	HRF EC	Ref. no.
min ⁻¹	V m ³ /h	kW	A	dB(A) at 4m	No.	+°C	ca. kg						
Alternating current, 1~, 230 Volt, 50/60 Hz, EC motor, protection category IP54													
1460	3000	0.12	1.10	49	1252	40	8.5	HQW EC 355 A	04916	HWW EC 355 A	04917	HRFW EC 355 A	04918
1980	4200	0.32	1.40	59	1047	40	12.0	HQW EC 355 B	04919	HWW EC 355 B	04920	HRFW EC 355 B	04921

Performance curves HQ EC / HW EC / HRF EC 355 A

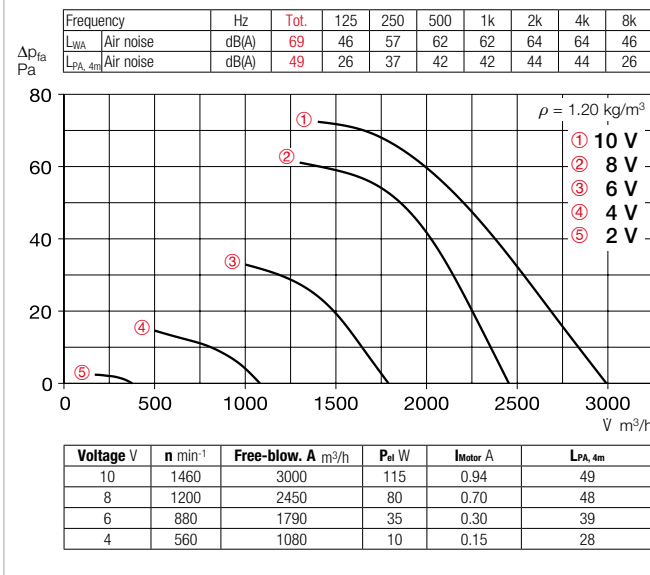

Performance curves HQ EC / HW EC / HRF EC 355 B

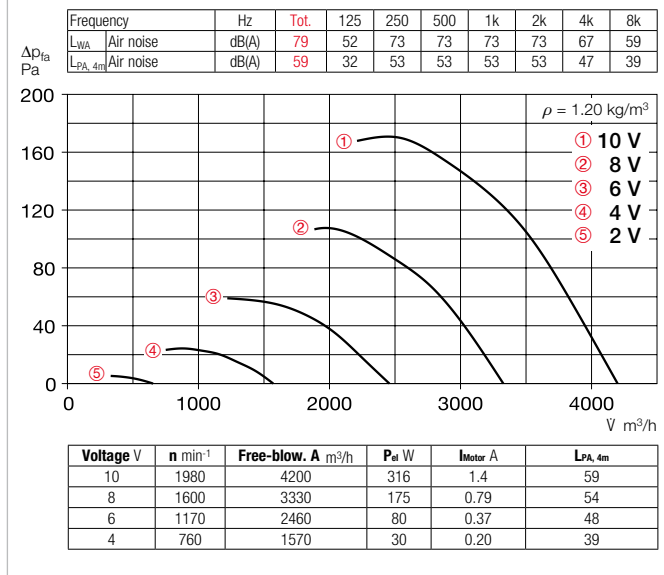

Accessories for HRF EC 355 Description see page 276 ff.

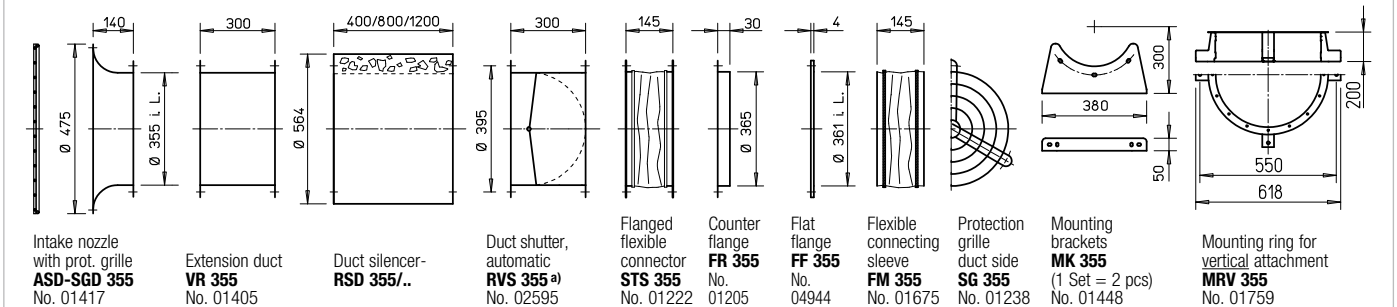

a) Shutter, motorised see Accessories product pages.

References	Page	Other accessories	Page
Techn. description	180	Filters and silencers	481 ff.
Selection table	181	Shutters and ventilation grilles	561 ff.
Planning information	14 ff.	Universal control system, electronic controller, Speed potentiometer	613 ff.

Special design
Different voltage, air flow direction, higher air flow temperature, acid protection upon request.

The technical information on p.19 ff. must be observed.

Universal control system		Speed potentiometer		Three level speed switch		Electronic pressure difference controller/ actuator		Electronic temperature controller/actuator					
Type	Ref. no.	Type	Ref. no.	Type	Ref. no.	Type	Ref. no.	Type	Ref. no.				
EUR EC ¹⁾	01347	PU 10 ¹⁾	01734	PA 10 ¹⁾	01735	SU-3 10 ¹⁾	04266	SA-3 10 ¹⁾	04267	EDR ¹⁾	01437	ETR ¹⁾	01438
EUR EC ¹⁾	01347	PU 10 ¹⁾	01734	PA 10 ¹⁾	01735	SU-3 10 ¹⁾	04266	SA-3 10 ¹⁾	04267	EDR ¹⁾	01437	ETR ¹⁾	01438

1) Multiple EC fans can normally be connected, see Accessories.

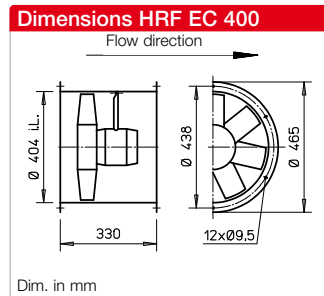
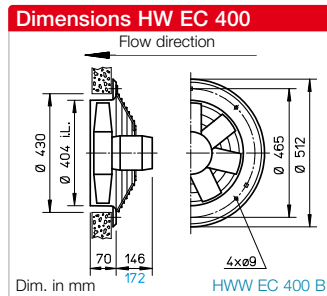
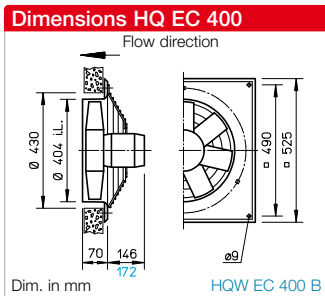
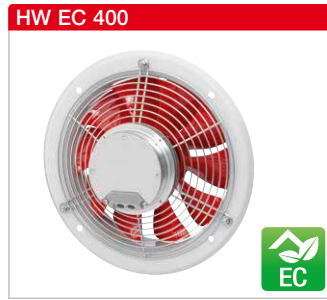

Description for all types

■ **Casing**

Made of galvanised steel sheet, types HQ and HW have additional two layer lacquer coating in papyrus white.

■ **Impeller**

High performance characteristics with profiled blades made of plastic, aerodynamically optimised for application, dynamically balanced.

■ **Drive**

Energy-saving, speed-controllable external rotor EC motor in protection category IP54 with the highest level of efficiency. Maintenance-free and radio interference-free, excellent electromagnetic compatibility (EMC), ball bearing mounted.

■ **Motor protection**

Integrated electronic temperature monitoring system for EC motor and electronics.

■ **Electrical connection**

Standard terminal box (protection category IP54). Mounted to external cable for HQ and HW types (version "A") or on back of motor (version "B"). Mounted on outside of duct for HRF types.

■ **Protection grille**

Made of powder-coated steel for HQ and HW in accordance with DIN EN ISO 13857.

■ **Power control**

All types are continuously controllable via internal (delivery) or external speed potentiometer. Control is also possible via three level switch or continuously variable via universal control system or electronic differential pressure/temperature controller. See type table. Performance levels are shown on the performance curve as examples.

■ **Installation**

Installation possible in any position.

■ **Noise levels**

The total level and range for the sound power level and sound pressure level at 4 m free field conditions are specified above the performance diagram for the average operating point on the inlet/outlet side. The total sound pressure level at 4 m (free field conditions) is also specified in the type table, as well as the table below the performance diagram for various voltages. See page 14 f for noise emissions and room acoustics.

Speed min ⁻¹	Flow rate-free-blowing V m ³ /h	Power consump. kW	Current consump. A	Sound pressure dB(A) in 4m	Wiring diagram No.	Max. air flow temperature +°C	Wgt net ca. kg	Design type					
								HQ EC incl. protection grille	Ref. no.	HW EC incl. protection grille	Ref. no.	HRF EC	Ref. no.
Alternating current, 1~, 230 Volt, 50/60 Hz, EC motor, protection category IP54													
1700	4790	0.32	1.40	59	1047	40	13.4	HQW EC 400 A	04922	HWW EC 400 A	04923	HRFW EC 400 A	04924
2150	5850	0.65	3.10	65	1201	40	15.4	HQW EC 400 B	04925	HWW EC 400 B	04926	HRFW EC 400 B	04927

Performance curves HQ EC / HW EC / HRF EC 400 A

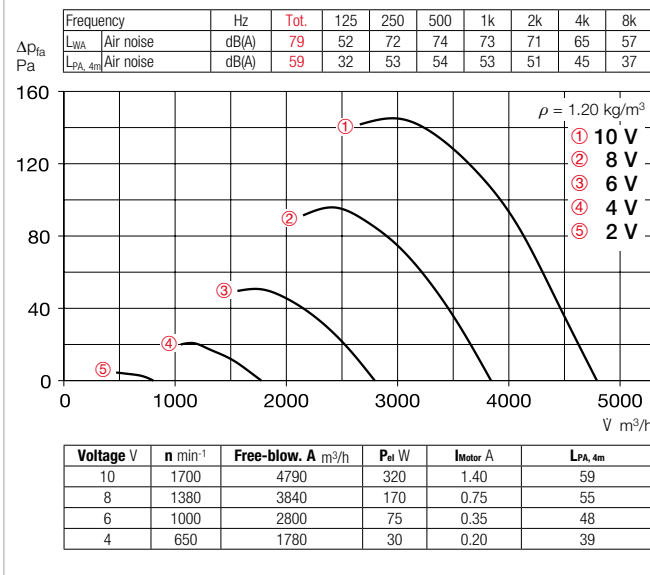

Performance curves HQ EC / HW EC / HRF EC 400 B

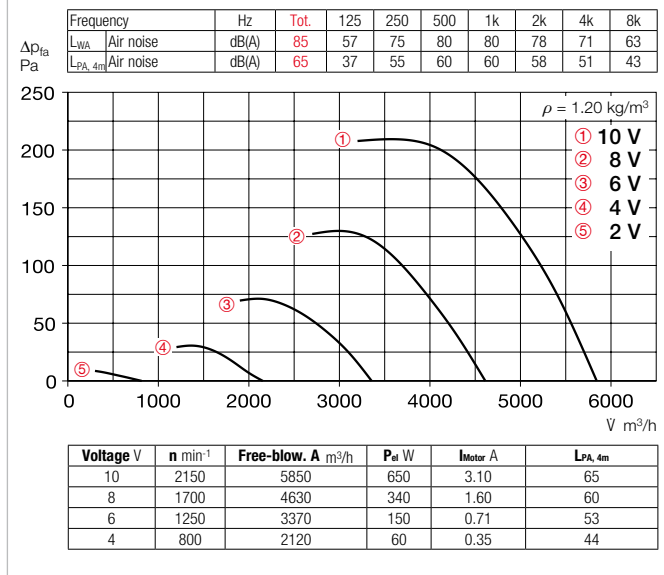

Accessories for HRF EC 400 Description see page 276 ff.

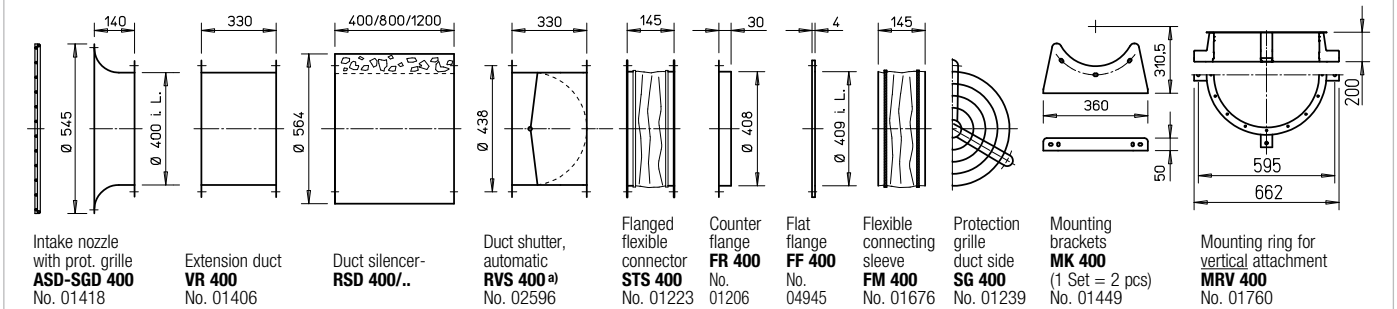

^{a)} Shutter, motorised see Accessories product pages.

References	Page
Techn. description	180
Selection table	181
Planning information	14 ff.

Special design
Different voltage, air flow direction, higher air flow temperature, acid protection upon request.

The technical information on p.19 ff. must be observed.

Other accessories	Page
Filters and silencers	481 ff.
Shutters and ventilation grilles	561 ff.
Universal control system, electronic controller, Speed potentiometer	613 ff.

Universal control system		Speed potentiometer		Three level speed switch		Electronic pressure difference controller/ actuator		Electronic temperature controller/actuator					
Type	Ref. no.	Type	Ref. no.	Type	Ref. no.	Type	Ref. no.	Type	Ref. no.				
EUR EC ¹⁾	01347	PU 10 ¹⁾	01734	PA 10 ¹⁾	01735	SU-3 10 ¹⁾	04266	SA-3 10 ¹⁾	04267	EDR ¹⁾	01437	ETR ¹⁾	01438
EUR EC ¹⁾	01347	PU 10 ¹⁾	01734	PA 10 ¹⁾	01735	SU-3 10 ¹⁾	04266	SA-3 10 ¹⁾	04267	EDR ¹⁾	01437	ETR ¹⁾	01438

¹⁾ Multiple EC fans can normally be connected, see Accessories.

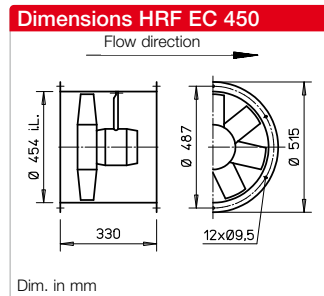
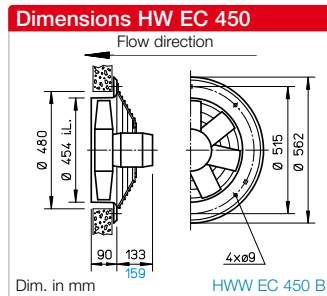
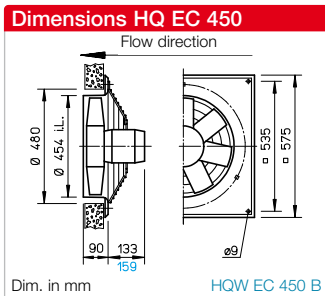

Description for all types

■ **Casing**

Made of galvanised steel sheet, types HQ and HW have additional two layer lacquer coating in papyrus white.

■ **Impeller**

High performance characteristics with profiled blades made of plastic, aerodynamically optimised for application, dynamically balanced.

■ **Drive**

Energy-saving, speed-control-lable external rotor EC motor in protection category IP54 with the highest level of efficiency. Maintenance-free and radio interference-free, excellent electromagnetic compatibility (EMC), ball bearing mounted.

■ **Motor protection**

Integrated electronic temperature monitoring system for EC motor and electronics.

■ **Electrical connection**

Standard terminal box (protection category IP54). Mounted to external cable for HQ and HW types (version "A") or on back of motor (version "B"). Mounted on outside of duct for HRF types.

■ **Protection grille**

Made of powder-coated steel for HQ and HW in accordance with DIN EN ISO 13857.

■ **Power control**

All types are continuously controllable via internal (delivery) or external speed potentiometer. Control is also possible via three level switch or continuously variable via universal control system or electronic differential pressure/temperature controller. See type table. Performance levels are shown on the performance curve as examples.

■ **Installation**

Installation possible in any position.

■ **Noise levels**

The total level and range for the sound power level and sound pressure level at 4 m free field conditions are specified above the performance diagram for the average operating point on the inlet/outlet side. The total sound pressure level at 4 m (free field conditions) is also specified in the type table, as well as the table below the performance diagram for various voltages. See page 14 f for noise emissions and room acoustics.

Speed	Flow rate-free-blowing	Power consump.	Current consump.	Sound pressure	Wiring diagram	Max. air flow temperature	Wgt net	Design type					
								HQ EC incl. protection grille	Ref. no.	HW EC incl. protection grille	Ref. no.	HRF EC	Ref. no.
min ⁻¹	V m ³ /h	kW	A	dB(A) at 4m	No.	+°C	ca. kg						
Alternating current, 1~, 230 Volt, 50/60 Hz, EC motor, protection category IP54													
1320	5460	0.29	1.30	55	1047	40	14.5	HQW EC 450 A	04928	HWW EC 450 A	04929	HRFW EC 450 A	04930
1835	7640	0.82	3.80	64	1201	40	16.5	HQW EC 450 B	04931	HWW EC 450 B	04932	HRFW EC 450 B	04933

Performance curves HQ EC / HW EC / HRF EC 450 A

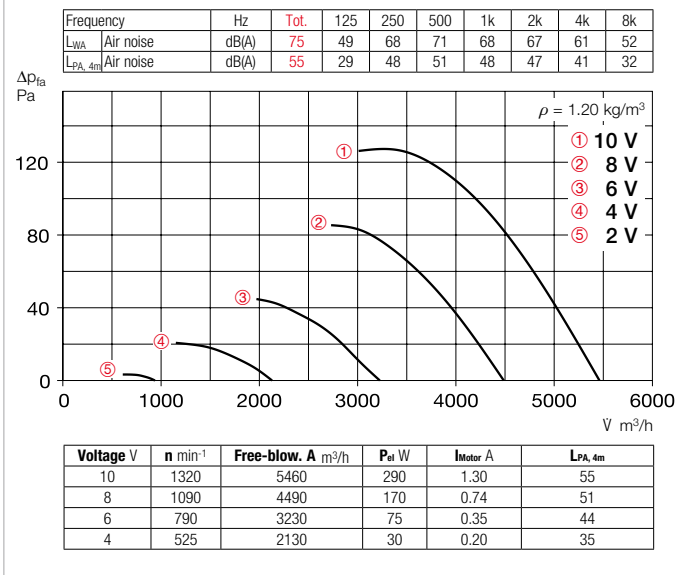

Performance curves HQ EC / HW EC / HRF EC 450 B

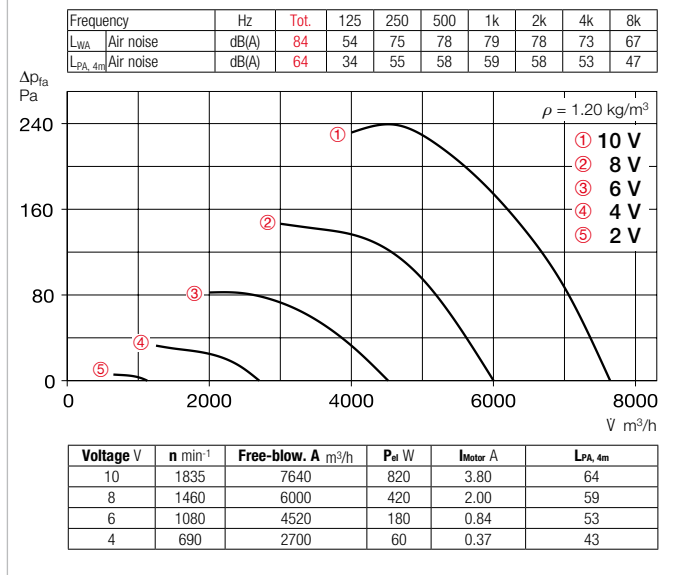

Accessories for HRF EC 450 Description see page 276 ff.

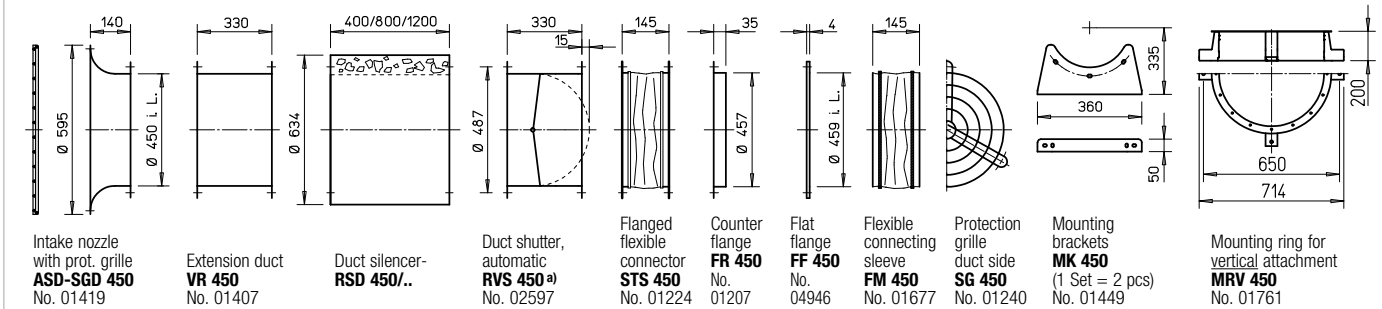

a) Shutter, motorised see Accessories product pages.

References	Page	Other accessories	Page
Techn. description	180	Filters and silencers	481 ff.
Selection table	181	Shutters and ventilation grilles	561 ff.
Planning information	14 ff.	Universal control system, electronic controller, Speed potentiometer	613 ff.

Special design
Different voltage, air flow direction, higher air flow temperature, acid protection upon request.

The technical information on p.19 ff. must be observed.

Universal control system		Speed potentiometer		Three level speed switch		Electronic pressure difference controller/ actuator		Electronic temperature controller/actuator					
Type	Ref. no.	Type	Ref. no.	Type	Ref. no.	Type	Ref. no.	Type	Ref. no.				
EUR EC ¹⁾	01347	PU 10 ¹⁾	01734	PA 10 ¹⁾	01735	SU-3 10 ¹⁾	04266	SA-3 10 ¹⁾	04267	EDR ¹⁾	01437	ETR ¹⁾	01438
EUR EC ¹⁾	01347	PU 10 ¹⁾	01734	PA 10 ¹⁾	01735	SU-3 10 ¹⁾	04266	SA-3 10 ¹⁾	04267	EDR ¹⁾	01437	ETR ¹⁾	01438

1) Multiple EC fans can normally be connected, see Accessories.

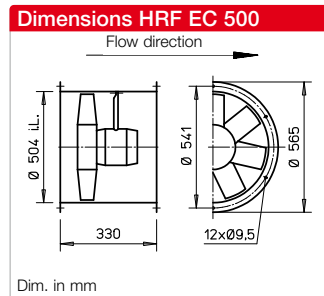
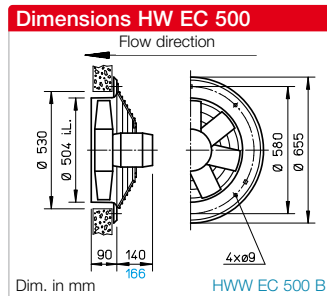
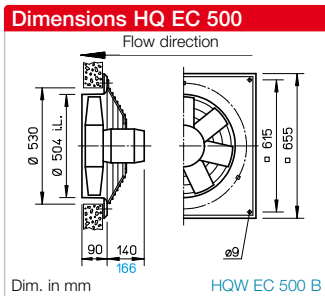
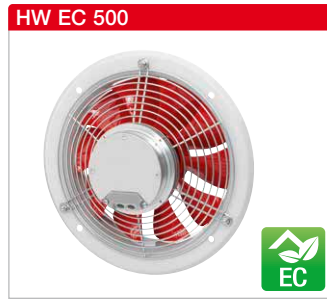

Description for all types

■ **Casing**

Made of galvanised steel sheet, types HQ and HW have additional two layer lacquer coating in papyrus white.

■ **Impeller**

High performance characteristics with profiled blades made of plastic, aerodynamically optimised for application, dynamically balanced.

■ **Drive**

Energy-saving, speed-control-able external rotor EC motor in protection category IP54 with the highest level of efficiency. Maintenance-free and radio interference-free, excellent electromagnetic compatibility (EMC), ball bearing mounted.

■ **Motor protection**

Integrated electronic temperature monitoring system for EC motor and electronics.

■ **Electrical connection**

Standard terminal box (protection category IP54). Mounted to external cable for HQ and HW types (version "A") or on back of motor (version "B"). Mounted on outside of duct for HRF types.

■ **Protection grille**

Made of powder-coated steel for HQ and HW in accordance with DIN EN ISO 13857.

■ **Power control**

All types are continuously controllable via internal (delivery) or external speed potentiometer. Control is also possible via three level switch or continuously variable via universal control system or electronic differential pressure/temperature controller. See type table. Performance levels are shown on the performance curve as examples.

■ **Installation**

Installation possible in any position.

■ **Noise levels**

The total level and range for the sound power level and sound pressure level at 4 m free field conditions are specified above the performance diagram for the average operating point on the inlet/outlet side. The total sound pressure level at 4 m (free field conditions) is also specified in the type table, as well as the table below the performance diagram for various voltages. See page 14 f for noise emissions and room acoustics.

Speed	Flow rate-free-blowing	Power consump.	Current consump.	Sound pressure	Wiring diagram	Max. air flow temperature	Wgt net	Design type					
								HQ EC incl. protection grille	Ref. no.	HW EC incl. protection grille	Ref. no.	HRF EC	Ref. no.
min ⁻¹	V m ³ /h	kW	A	dB(A) at 4m	No.	+°C	ca. kg						
Alternating current, 1~, 230 Volt, 50/60 Hz, EC motor, protection category IP54													
1090	6320	0.29	1.30	54	1047	40	15.7	HQW EC 500 A	04934	HWW EC 500 A	04935	HRFW EC 500 A	04936
1450	8300	0.67	3.00	62	1201	40	17.7	HQW EC 500 B	04937	HWW EC 500 B	04938	HRFW EC 500 B	04939

Performance curves HQ EC / HW EC / HRF EC 500 A

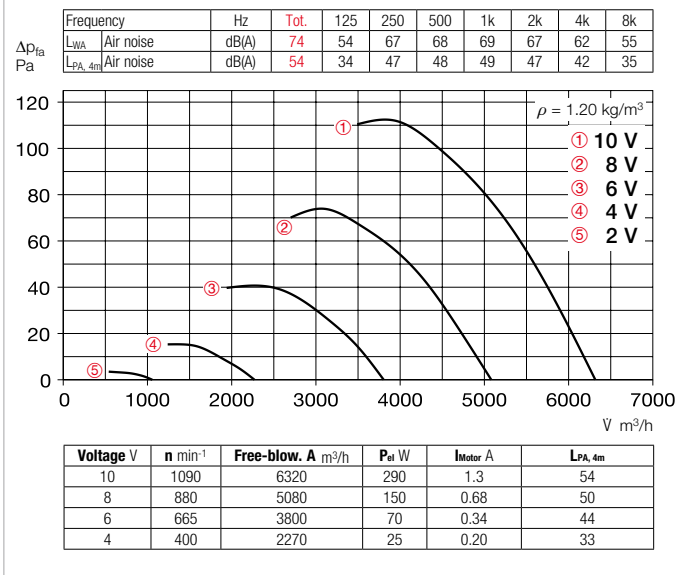

Performance curves HQ EC / HW EC / HRF EC 500 B

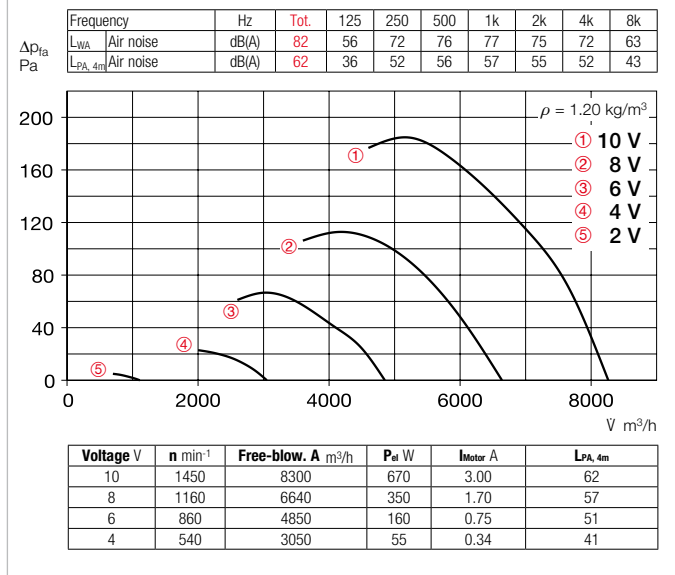

Accessories for HRF EC 500 Description see page 276 ff.

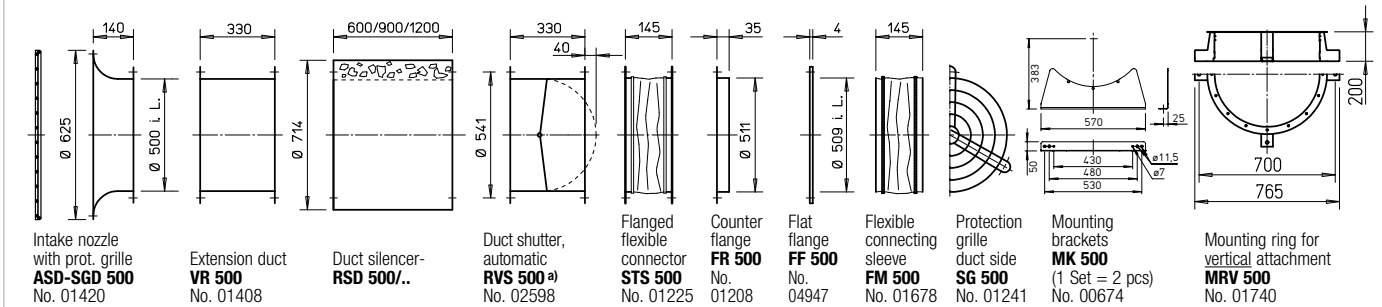

^{a)} Shutter, motorised see Accessories product pages.

References	Page	Other accessories	Page
Techn. description	180	Filters and silencers	481 ff.
Selection table	181	Shutters and ventilation grilles	561 ff.
Planning information	14 ff.	Universal control system, electronic controller, Speed potentiometer	613 ff.

Special design
Different voltage, air flow direction, higher air flow temperature, acid protection upon request.

The technical information on p.19 ff. must be observed.

Universal control system		Speed potentiometer		Three level speed switch		Electronic pressure difference controller/ actuator		Electronic temperature controller/actuator					
Type	Ref. no.	Type	Ref. no.	Type	Ref. no.	Type	Ref. no.	Type	Ref. no.				
EUR EC ¹⁾	01347	PU 10 ¹⁾	01734	PA 10 ¹⁾	01735	SU-3 10 ¹⁾	04266	SA-3 10 ¹⁾	04267	EDR ¹⁾	01437	ETR ¹⁾	01438
EUR EC ¹⁾	01347	PU 10 ¹⁾	01734	PA 10 ¹⁾	01735	SU-3 10 ¹⁾	04266	SA-3 10 ¹⁾	04267	EDR ¹⁾	01437	ETR ¹⁾	01438

¹⁾ Multiple EC fans can normally be connected, see Accessories.

HRF EC 560

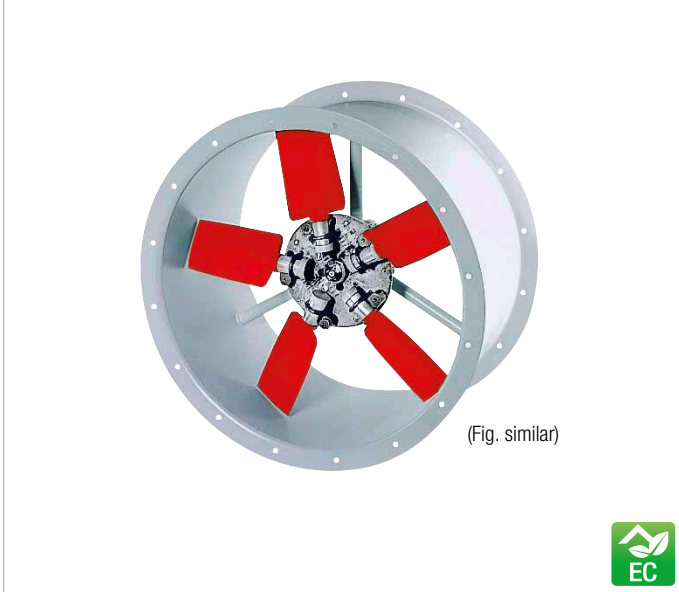

Dimensions HRF EC 560

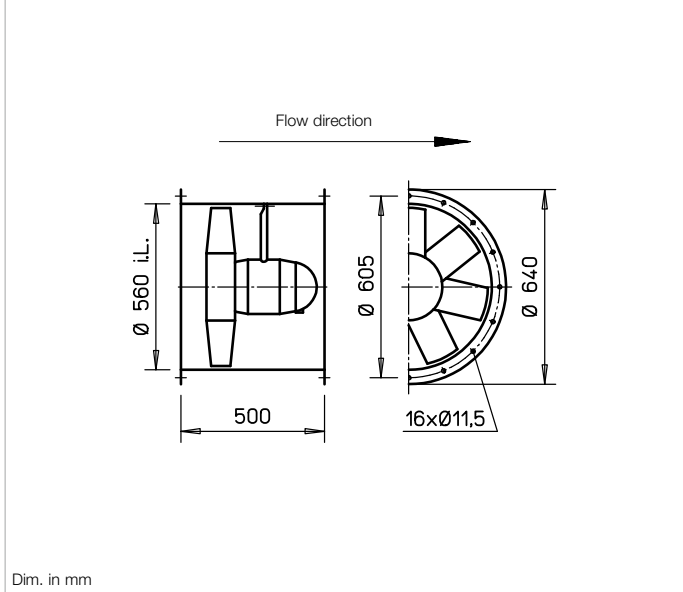

■ **Description**

High performance axial EC fan in pipe sleeve, with double-sided flanges for direct intermediate setting in pipelines. Flange in accordance with DIN 24155, p. 3.

■ **Casing**

Made of galvanised steel sheet, additional terminal box (IP54) on outside of duct.

■ **Impeller**

High performance characteristics with profiled blades made of plastic, aerodynamically optimised for application, dynamically balanced.

■ **Drive**

Energy-saving, speed-controllable external rotor EC motor in protection category IP54 with the highest level of efficiency. Maintenance-free and radio interference-free, excellent electromagnetic compatibility (EMC), ball bearing mounted.

■ **Motor protection**

Integrated electronic temperature monitoring system for EC motor and electronics.

■ **Electrical connection**

Standard terminal box (protection category IP54) on back of motor, additional terminal box on outside of duct.

■ **Power control**

All types are continuously controllable via internal (delivery) or external speed potentiometer. Control is also possible via three level switch or continuously variable via universal control system or electronic differential pressure/temperature controller. See type table.

■ **Installation**

Installation possible in any position.

■ **Noise levels**

The total level and range for the sound power level and sound pressure level at 4 m free field conditions are specified above the performance diagram for the average operating point on the inlet/outlet side. The total sound pressure level at 4 m (free field conditions) is also specified in the type table, as well as the table below the performance diagram for various voltages. See page 14 f for noise emissions and room acoustics.

Speed	Flow rate-free-blowing	Power consump.	Current consum.	Sound pressure	Wiring diagram	Max. air flow temperature	Wgt net	Design type	
								HRF EC	Ref. no.
min ⁻¹	V m ³ /h	kW	A	dB(A) at 4m	No.	+°C	ca. kg		
Alternating current, 1~, 230 Volt, 50/60 Hz, EC motor, protection category IP54									
1200	9740	0.56	2.45	55	1201	40	35	HRFW EC 560	04874

Performance curves HRF EC 560 A

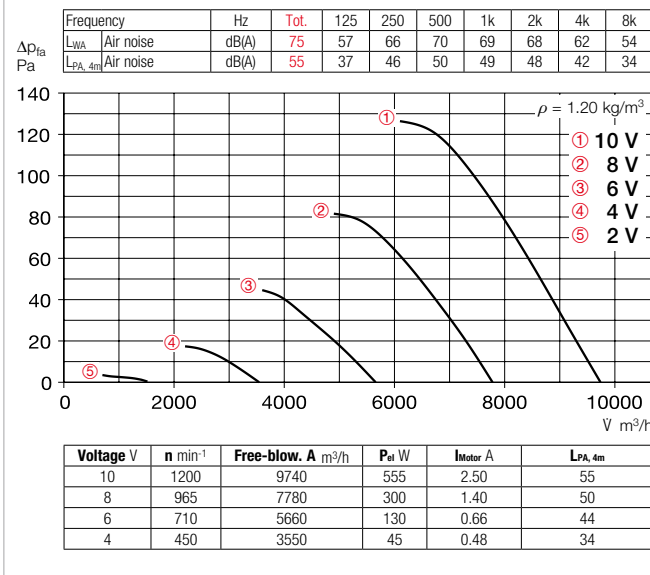

Accessories for HRF EC 560 Description see page 276 ff.

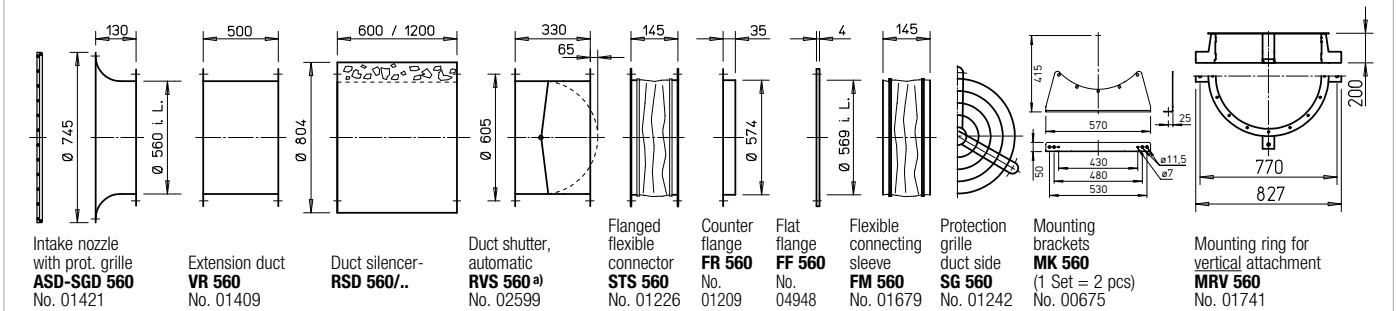

^{a)} Shutter, motorised see Accessories product pages.

References	Page	Other accessories	Page
Techn. description	180	Filters and silencers	481 ff.
Selection table	181	Shutters and ventilation grilles	561 ff.
Planning information	14 ff.	Universal control system, electronic controller, Speed potentiometer	613 ff.

Special design
Different voltage, air flow direction, higher air flow temperature, acid protection upon request.

The technical information on p.19 ff. must be observed.

Universal control system		Speed potentiometer		Three level speed switch		Electronic pressure difference controller/ actuator		Electronic temperature controller/actuator					
Type	Ref. no.	Type	Ref. no.	Type	Ref. no.	Type	Ref. no.	Type	Ref. no.				
EUR EC ¹⁾	01347	PU 10 ¹⁾	01734	PA 10 ¹⁾	01735	SU-3 10 ¹⁾	04266	SA-3 10 ¹⁾	04267	EDR ¹⁾	01437	ETR ¹⁾	01438

¹⁾ Multiple EC fans can normally be connected, see Accessories.

HRF EC 630

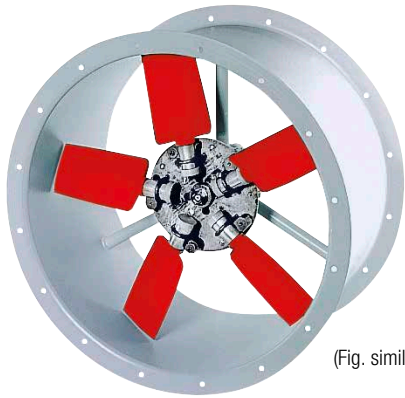

(Fig. similar)



Dimensions HRF EC 630

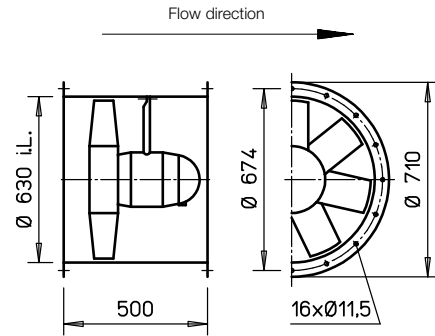

Dim. in mm

■ Description

High performance axial EC fan in pipe sleeve, with double-sided flanges for direct intermediate setting in pipelines. Flange in accordance with DIN 24155, p. 3.

■ Casing

Made of galvanised steel sheet, additional terminal box (IP54) on outside of duct.

■ Impeller

High performance characteristics with profiled blades made of plastic, aerodynamically optimised for application, dynamically balanced.

■ Drive

Energy-saving, speed-controllable external rotor EC motor in protection category IP54 with the highest level of efficiency. Maintenance-free and radio interference-free, excellent electromagnetic compatibility (EMC), ball bearing mounted.

■ Motor protection

Integrated electronic temperature monitoring system for EC motor and electronics.

■ Electrical connection

Standard terminal box (protection category IP54) on back of motor, additional terminal box on outside of duct.

■ Power control

All types are continuously controllable via internal (delivery) or external speed potentiometer. Control is also possible via three level switch or continuously variable via universal control system or electronic differential pressure/temperature controller. See type table.

■ Installation

Installation possible in any position.

■ Noise levels

The total level and range for the sound power level and sound pressure level at 4 m free field conditions are specified above the performance diagram for the average operating point on the inlet/outlet side. The total sound pressure level at 4 m (free field conditions) is also specified in the type table, as well as the table below the performance diagram for various voltages. See page 14 f for noise emissions and room acoustics.

Speed	Flow rate-free-blowing	Power consump.	Current consum.	Sound pressure	Wiring diagram	Max. air flow temperature	Wgt net	Design type	
								HRF EC	Ref. no.
min ⁻¹	V m ³ /h	kW	A	dB(A) at 4m	No.	+°C	ca. kg		
Alternating current, 1~, 230 Volt, 50/60 Hz, EC motor, protection category IP54									
960	10330	0.45	2.20	54	1201	40	37	HRFW EC 630	04875

Performance curves HRF EC 630 A

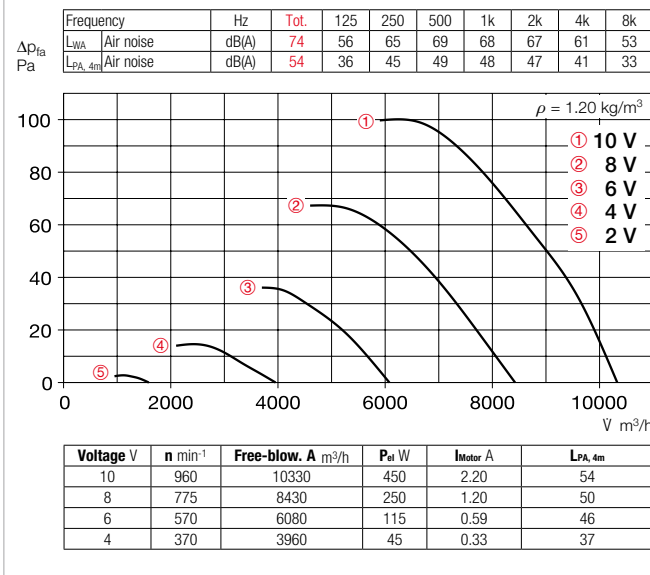

Accessories for HRF EC 630 Description see page 276 ff.

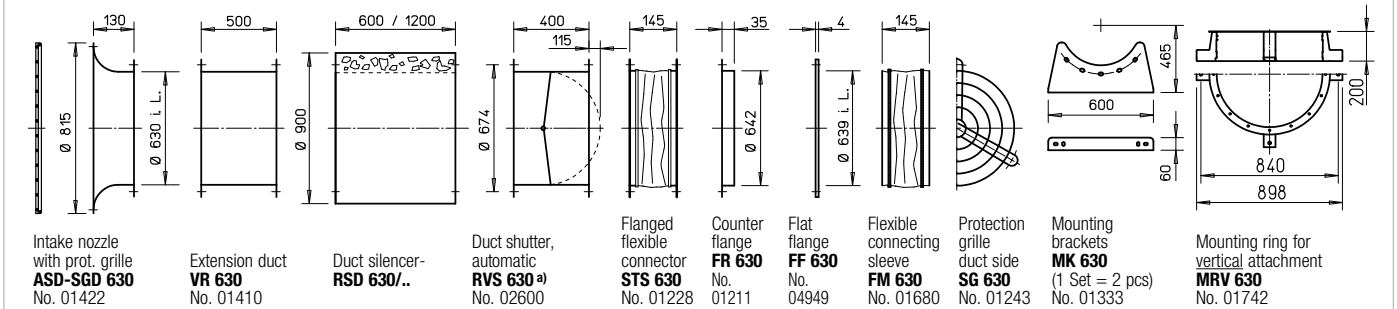

^{a)} Shutter, motorised see Accessories product pages.

References	Page	Other accessories	Page
Techn. description	180	Filters and silencers	481 ff.
Selection table	181	Shutters and ventilation grilles	561 ff.
Planning information	14 ff.	Universal control system, electronic controller, Speed potentiometer	613 ff.

Special design
Different voltage, air flow direction, higher air flow temperature, acid protection upon request.

The technical information on p.19 ff. must be observed.

Universal control system		Speed potentiometer		Three level speed switch		Electronic pressure difference controller/ actuator		Electronic temperature controller/actuator					
Type	Ref. no.	Type	Ref. no.	Type	Ref. no.	Type	Ref. no.	Type	Ref. no.				
EUR EC ¹⁾	01347	PU 10 ¹⁾	01734	PA 10 ¹⁾	01735	SU-3 10 ¹⁾	04266	SA-3 10 ¹⁾	04267	EDR ¹⁾	01437	ETR ¹⁾	01438

¹⁾ Multiple EC fans can normally be connected, see Accessories.

HRF EC 710

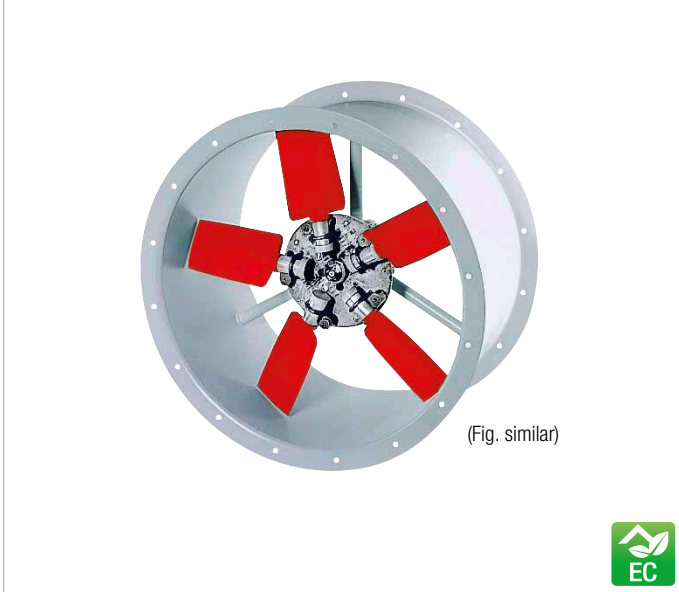

Dimensions HRF EC 710

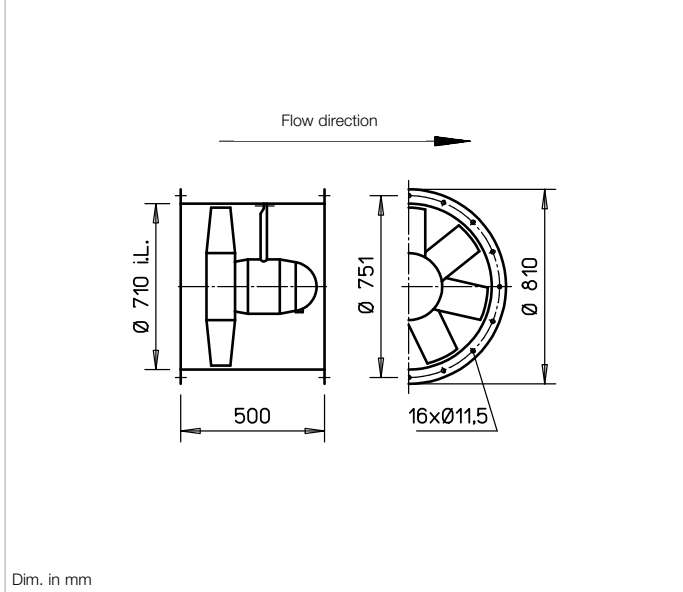

■ Description

High performance axial EC fan in pipe sleeve, with double-sided flanges for direct intermediate setting in pipelines. Flange in accordance with DIN 24155, p. 3.

■ Casing

Made of galvanised steel sheet, additional terminal box (IP54) on outside of duct.

■ Impeller

High performance characteristics with profiled blades made of plastic, aerodynamically optimised for application, dynamically balanced.

■ Drive

Energy-saving, speed-controllable external rotor EC motor in protection category IP54 with the highest level of efficiency. Maintenance-free and radio interference-free, excellent electromagnetic compatibility (EMC), ball bearing mounted.

■ Motor protection

Integrated electronic temperature monitoring system for EC motor and electronics.

■ Electrical connection

Standard terminal box (protection category IP54) on back of motor, additional terminal box on outside of duct.

■ Power control

All types are continuously controllable via internal (delivery) or external speed potentiometer. Control is also possible via three level switch or continuously variable via universal control system or electronic differential pressure/temperature controller. See type table.

■ Installation

Installation possible in any position.

■ Noise levels

The total level and range for the sound power level and sound pressure level at 4 m free field conditions are specified above the performance diagram for the average operating point on the inlet/outlet side. The total sound pressure level at 4 m (free field conditions) is also specified in the type table, as well as the table below the performance diagram for various voltages. See page 14 f for noise emissions and room acoustics.

Speed	Flow rate-free-blowing	Power consump.	Current consum.	Sound pressure	Wiring diagram	Max. air flow temperature	Wgt net	Design type	
								HRF EC	Ref. no.
min ⁻¹	V m ³ /h	kW	A	dB(A) at 4m	No.	+°C	ca. kg		
Three-phase current, 3~, 400 Volt, 50/60 Hz, EC motor, protection category IP54									
1100	19400	1.32	2.10	61	1201	40	40	HRFD EC 710	04876

Performance curves HRF EC 710 A

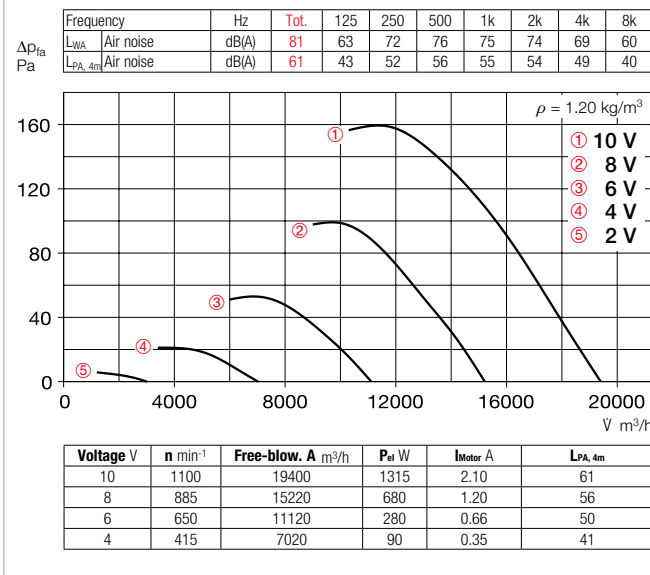

Accessories for HRF EC 710 Description see page 276 ff.

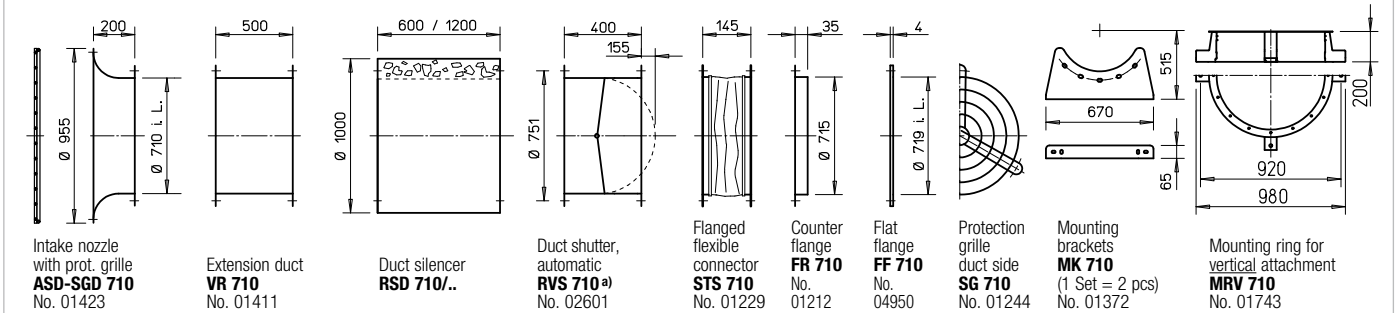

^{a)} Shutter, motorised see Accessories product pages.

References	Page
Techn. description	180
Selection table	181
Planning information	14 ff.

Special design
Different voltage, air flow direction, higher air flow temperature, acid protection upon request.

The technical information on p.19 ff. must be observed.

Other accessories	Page
Filters and silencers	481 ff.
Shutters and ventilation grilles	561 ff.
Universal control system, electronic controller, Speed potentiometer	613 ff.

Universal control system		Speed potentiometer		Three level speed switch		Electronic pressure difference controller/actuator		Electronic temperature controller/actuator					
Type	Ref. no.	Type	Ref. no.	Type	Ref. no.	Type	Ref. no.	Type	Ref. no.				
EUR EC ¹⁾	01347	PU 10 ¹⁾	01734	PA 10 ¹⁾	01735	SU-3 10 ¹⁾	04266	SA-3 10 ¹⁾	04267	EDR ¹⁾	01437	ETR ¹⁾	01438

¹⁾ Multiple EC fans can normally be connected, see Accessories.

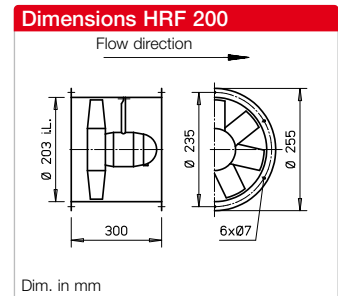
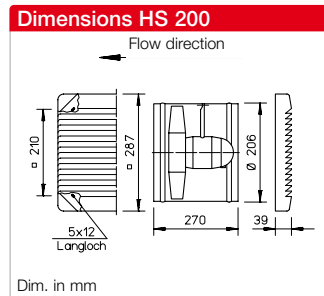
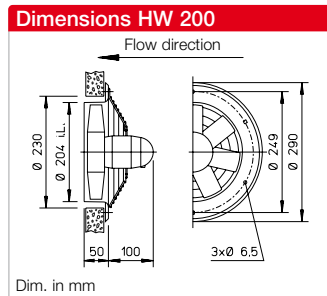
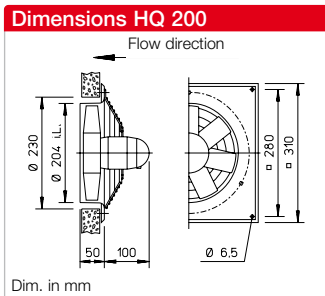

Description for all types

- **Casing**
 Made of galvanised steel sheet, types HQ and HW have additional two layer lacquer coating in papyrus white.
- **Impeller**
 High performance characteristics with profiled blades made of plastic, dynamically balanced.
- **Drive**
 Closed casing made of die-cast aluminium. Protection category IP54, ball bearing mounted. Maintenance-free and radio interference-free. Winding with moisture proof coating. See type table for max. air flow temperature.

- **Motor protection**
 Through built-in thermal contacts wired in series with the winding, automatic deactivation and reactivation after cool down.
- **Electrical connection**
 Standard terminal box (IP54) on back of motor. Additionally on outside of duct for HRF types.
- **Protection grille**
 Made of powder-coated steel for HQ and HW, and plastic for HS. In accordance with DIN EN ISO 13857.
- **Power control**
 All types can be controlled through voltage reduction (electronic or via transformer). The flow rates are shown in the performance diagram.

- **Reverse operation**
 All types are reversible using a DSEL switch. Performance reduction of approx. 1/3 in abnormal flow direction.
- **Installation**
 Installation possible in any position, but be aware of any condensate drain holes depending on usage.
- **Noise levels**
 See performance diagram. The sound power and sound pressure at 1 m distance under free field conditions are specified for the average operating point on the inlet/outlet side. See page 14 f for noise emissions and room acoustics.

Reference	Page
Techn. description	180
Selection table	181
Planning information	14 ff.
Special design	
Different voltage, protection category, air flow direction, higher air flow temperature, acid protection and impeller in other materials upon request.	
The technical information on p. 19 ff. must be observed.	

Speed min ⁻¹	Flow rate free-blowing V m ³ /h	Power consump. W	Current consump.		Wiring dia- gram No.	Max. air flow temp.		Weight net aprx. kg	Design type							
			at rated voltage A	max. with control A		at rated voltage + °C	with control + °C		HQ incl. Ref. no. protection grille		HW incl. Ref. no. protection grille		HS incl. Ref. no. protection grille		HRF Ref. no.	
1360	520	25	0.11	0.11	439 ¹⁾	60	40	3.8	HQW 200/4	07537	HW 200/4	07538	HSW 200/4	07502	HRFW 200/4 ¹⁾	07540
2250	930	66	0.26	0.31	439 ¹⁾	40	40	2.7	HQW 200/2	00960	–	–	HSW 200/2	07503	HRFW 200/2 ¹⁾	00199

¹⁾ Type HRFW: Connection according to wiring diagram no. 962.

Performance curves 200/2

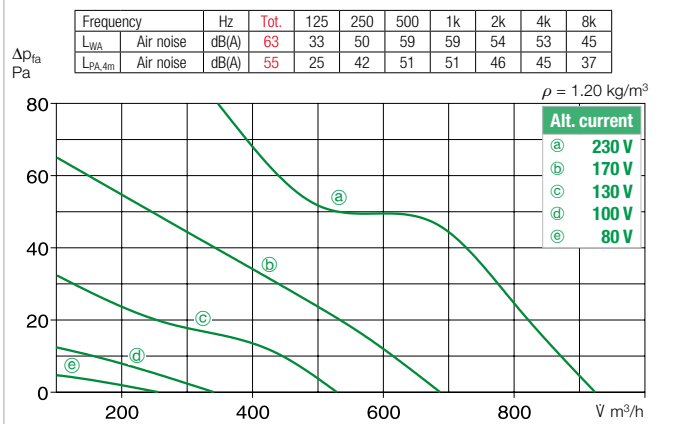

Performance curves 200/4

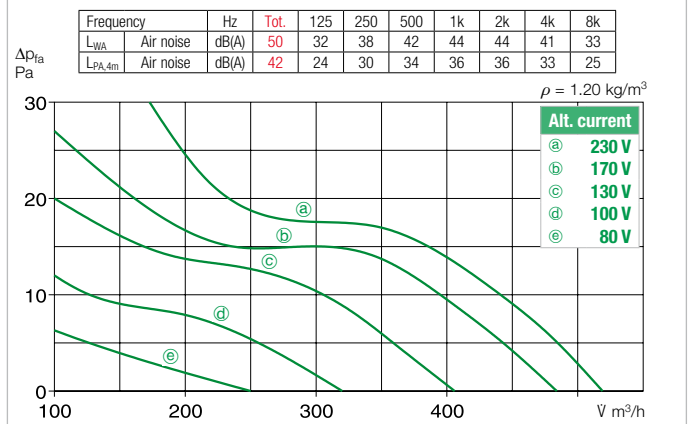

Accessories for HRF 200 Description see page 276 ff.

<p>Intake nozzle ASD 200 No. 01388</p>	<p>Flanged flexible connector STS 200 No. 01219</p>	<p>Counter flange FR 200 No. 01202</p>	<p>Flexible connecting sleeve FM 200 No. 01670</p>	<p>Protection grille duct side SG 200 No. 01216</p>	<p>2 mounting brackets 1 x MK 200 (= 2 pcs) No. 01446</p>	<p>4 vibration dampers for tensile load 1 x SDZ 1 (= 4 Pc) No.01454 4 vibration dampers for compression load 1 x SDD 1 (= 4 Pc) No.01452</p>
---	--	---	---	--	--	--

Type	Ref. no.	Type	Ref. no.	Type	Ref. no.	Type	Ref. no.
Transformer speed controller 5-step		Electronic speed controller, continuously variable flush-m./surface-m.		Reverser switch		Electronic speed controller with reverser switch	
TSW 0.3	03608	ESU 1/ESA 1	00236/00238	DSEL 2	01306	BSX	00240
TSW 0.3	03608	ESU 1/ESA 1	00236/00238	DSEL 2	01306	BSX	00240

Other accessories Page

Extension sleeve for HS VH 200 Ref. no. 01349
Cylindrical pipe section, galvanised steel, 15 cm long.

Filters and silencers 481 ff.
shutters and ventilation grilles 561 ff.
Speed controllers, controllers and switches 599 ff.

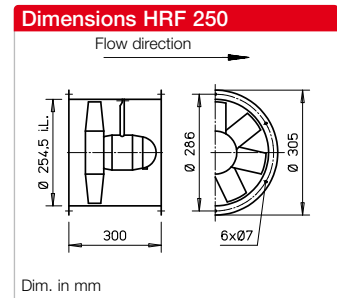
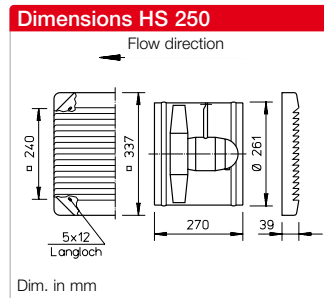
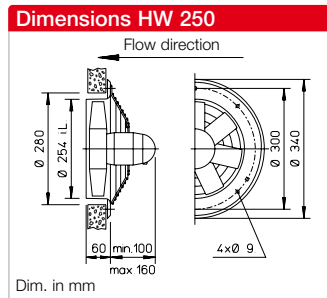
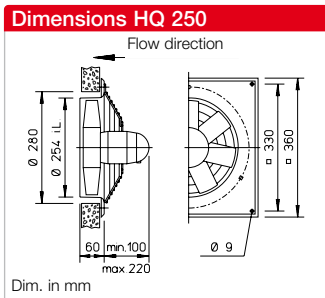

Description for all types

- **Casing**
 Made of galvanised steel sheet, types HQ and HW have additional two layer lacquer coating in papyrus white. Explosion-proof types have no lacquer coating.
- **Impeller**
 High performance characteristics with profiled blades made of plastic, dynamically balanced. Different for explosion-proof types.
- **Drive**
 Closed die-cast aluminium casing. Protection category IP55 or IP54. Ball bearing mounted. Maintenance-free and radio interference-free. Winding with moisture proof coating. See type table for max. air flow temperature. Different for explosion-proof types.

- **Motor protection**
 All types (except for 3~ explosion-proof) are equipped 180th thermal contacts. These should be wired with the motor protection circuit breaker (see type table) for effective motor protection. For types H..W 250/6, H..W 250/4 and all 1~ explosion-proof fans, the thermal contacts are wired in series with the winding, automatic deactivation and reactivation after cool down.
- **Electrical connection**
 Standard terminal box (IP54/55) on back of motor. Additionally on outside of duct for HRF types. Different for explosion-proof types.
- **Protection grille**
 Made of powder-coated steel for HQ/HW (HQ Ex galvanised), and plastic for HS. In accordance with DIN EN ISO 13857.

- **Power control**
 The voltage-controllable types are identified in the "Current consumption max. with control" column with a value which must be observed when determining the controller (see speed controller column). Possible assignments of frequency inverters to fans are shown in the performance diagram. The flow rates are shown in the performance diagram.
- **Reverse operation**
 All types are reversible using a reverser switch. Performance reduction of approx. 1/3 in abnormal flow direction.
- **Installation**
 Installation possible in any position, but be aware of any condensate drain holes depending on usage.

- **Dimensions**
 Pole-changeable and explosion-proof types may differ from the above information.
- **Noise levels**
 See performance diagram. The sound power and sound pressure at 4 m distance under free field conditions are specified for the average operating point on the inlet/outlet side. See page 14 f for noise emissions and room acoustics. Different for explosion-proof types.

Reference	Page
Techn. description	180
Selection table	181
Planning information	14 ff.

Speed	Flow rate free-blowing	Power consump.	Current consump.		Wiring diagram	Max. air flow temp.		Weight net appr.	Design type							
			at rated voltage	max. with control		at rated voltage	with control		HQ incl. protection grille	Ref. no.	HW incl. protection grille	Ref. no.	HS incl. protection grille	Ref. no.	HRF	Ref. no.
min ⁻¹	V m ³ /h	W	A	A	No.	+ °C	+ °C	kg								
Single-phase alternating current, 230 Volt, 50 Hz, Capacitor motor, protection category IP54/55																
930	660	35	0.20	0.22	317	60	40	6.5	HQW 250/6	01102	—	—	HSW 250/6	00139	—	—
1300	930	36	0.15	0.15	439 ¹⁾	60	40	7.5	HQW 250/4 ¹⁾	01103	HWW 250/4 ¹⁾	01001	HSW 250/4 ¹⁾	00140	HRFW 250/4 ¹⁾²⁾	00200
2710	2070	187	0.81	0.9	317 ¹⁾	60	40	6.5	HQW 250/2	01104	HWW 250/2	01002	HSW 250/2	00141	HRFW 250/2 ³⁾	00201
Three-phase current, 400 Volt, 50 Hz, Squirrel-cage rotor, protection category IP55																
980	700	61	0.27	0.33	469	60	40	6.5	HQD 250/6	01114	—	—	—	—	—	—
1390	950	55	0.15	0.15	469	60	40	6.5	HQD 250/4 ¹⁾	01115	HWD 250/4 ¹⁾	01016	HSD 250/4 ¹⁾	00155	HRFD 250/4 ¹⁾	00220
2550	2000	169	0.31	0.33	469	60	40	6.5	HQD 250/2	01116	HWD 250/2	01017	—	—	HRFD 250/2	00221
Pole-changeable, 2 speeds, three-phase current, Dahlander winding, 400 Volt, 50 Hz, protection category IP55																
1430/2770	1030/2110	58/212	0.16/0.43	—	472	60	—	8.5	HQD 250/4/2	01128	—	—	—	—	HRFD 250/4/2	00390
Ex Ex Explosion-proof, II 2G Ex h IIB T3 Gb, Motor Ex d, alternating current 230 Volt, 50 Hz, protection category IP55																
1400	1030	60*	0.70*	—	757	40	—	12	HQW 250/4 Ex	00438	—	—	—	—	HRFW 250/4 Ex	00437
2690	1950	180*	1.23*	—	757	40	—	13	HQW 250/2 Ex	01094	—	—	—	—	HRFW 250/2 Ex	01095
Ex Ex Explosion-proof, II 2G Ex h IIB + H₂ T3 Gb, Motor Ex e, three-phase current 400 Volt, 50 Hz, protection category IP55																
1350	1070	120*	0.37*	—	470	40	—	12	HQD 250/4 Ex	01144	—	—	—	—	HRFD 250/4 Ex	00470
2800	2070	250*	0.75*	—	470	40	—	11	HQD 250/2 Ex	01145	—	—	—	—	HRFD 250/2 Ex	00471

* Motor ratings, Ex see information on page 20. ¹⁾ Special design not possible. ²⁾ Type HRFW../4: Connection according to wiring diagram no. 962. ³⁾ Type HRFW../2: Connection according to wiring diagram no. 963.

Performance curves 250/2

Frequency	Hz	Tot.	125	250	500	1k	2k	4k	8k	
L _{WA}	Air noise	dB(A)	75	38	53	66	68	70	69	62
L _{PA,4m}	Air noise	dB(A)	55	18	33	46	48	49	48	42

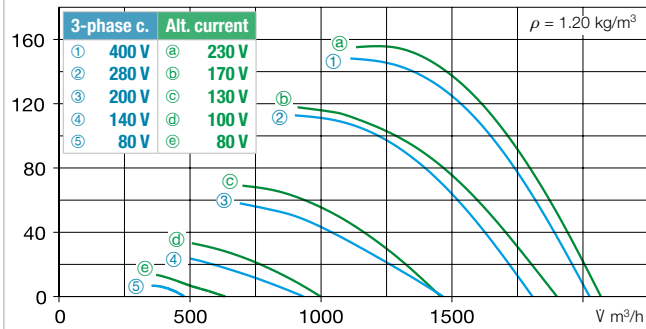

Performance curves 250/4 Alternating current

Frequency	Hz	Tot.	125	250	500	1k	2k	4k	8k	
L _{WA}	Air noise	dB(A)	58	41	52	53	51	49	43	29
L _{PA,4m}	Air noise	dB(A)	38	21	32	33	31	29	23	9

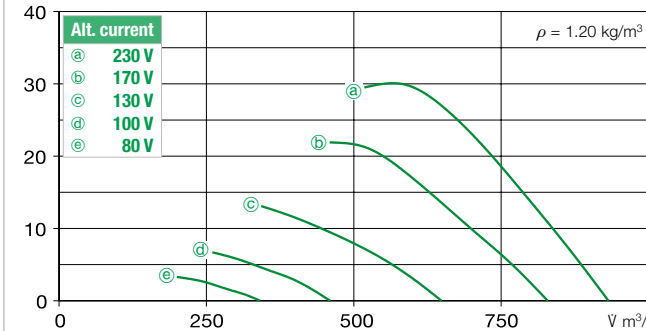

Performance curves 250/4 Three-phase current

Frequency	Hz	Tot.	125	250	500	1k	2k	4k	8k	
L _{WA}	Air noise	dB(A)	60	34	49	53	53	54	50	38
L _{PA,4m}	Air noise	dB(A)	40	14	29	33	33	34	30	18

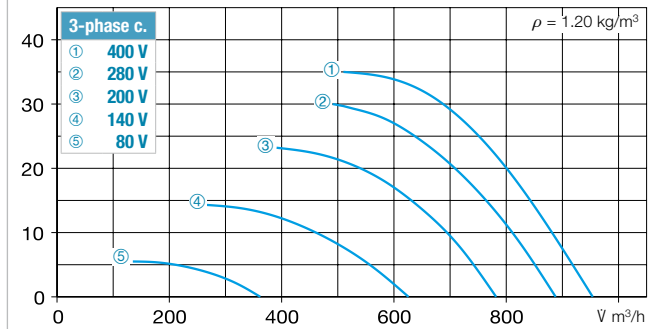

Performance curves 250/6

Frequency	Hz	Tot.	125	250	500	1k	2k	4k	8k	
L _{WA}	Air noise	dB(A)	53	40	47	47	46	43	37	30
L _{PA,4m}	Air noise	dB(A)	33	20	27	27	26	23	17	10

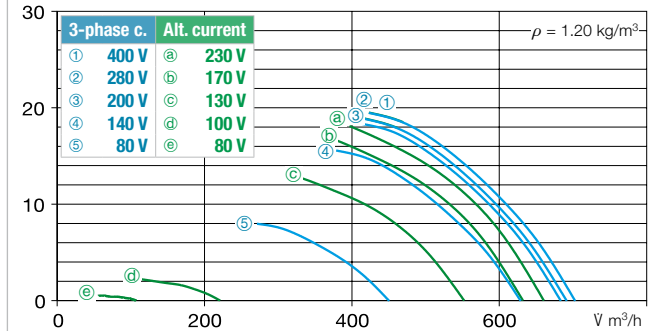

Accessories for HRF 250 Description see page 276 ff.

Intake nozzle with prot. grille **ASD-SGD 250** No. 01414

Extension duct **VR 250** No. 01402

Duct silencer **RSD 250/..**

Duct shutter, automatic **RVS 250 a)** No. 02592

Flanged flexible connector **STS 250 b)** No. 01220

Counter flange **FR 250** No. 01203

Flat flange **FF 250** No. 04941

Flexible connecting sleeve **FM 250 b)** No. 01672

Protection grille duct side **SG 250** No. 01236

2 mounting brackets **1 x MK 250** (= 2 pcs) No. 01447

4 vibration dampers for tensile load **1 x SDZ 1** (= 4 Pc) No. 01454

4 vibration dampers for compression load **1 x SDD 1** (= 4 Pc) No. 01452

a) Shutter, motorised see Accessories product pages.

b) See below for types for explosion-proof fans.

Frequency inverter with integrated sine filter		Transformer speed controller 5-step, pole changing switch		Electronic speed controller, continuously variable flush-m./surface-m.		Motor protection circuit breaker for connecting built-in thermal contacts		Reverser switch	
Type	Ref. no.	Type	Ref. no.	Type	Ref. no.	Type	Ref. no.	Type	Ref. no.
—	—	TSW 0.3	03608	ESU 1/ESA 1	00236/00238	—	—	WS	01271
—	—	TSW 0.3	03608	ESU 1/ESA 1	00236/00238	—	—	DSEL 2	01306
—	—	MWS 1.5⁴⁾	01947	ESU 3/ESA 3	00237/00239	MW	01579	WS	01271
FU-BS 2.5⁴⁾	05459	RDS 1⁴⁾	01314	—	—	MD	05849	WS	01271
FU-BS 2.5⁴⁾	05459	RDS 1⁴⁾	01314	—	—	MD	05849	WS	01271
FU-BS 2.5⁴⁾	05459	RDS 1⁴⁾	01314	—	—	MD	05849	WS	01271
—	—	Pole changing switch		—	—	—	—	—	—
—	—	PDA 12⁵⁾	05081	—	—	M 3⁶⁾	01293	PWDA	01282
—	—	not permitted	not permitted	not permitted	not permitted	—	—	—	—
—	—	not permitted	not permitted	not permitted	not permitted	—	—	—	—
—	—	not permitted	not permitted	not permitted	not permitted	—	—	—	—
—	—	not permitted	not permitted	not permitted	not permitted	—	—	—	—

⁴⁾ Incl. motor protection circuit breaker. ⁵⁾ Incl. speed pole changing switch. ⁶⁾ Flush-m. version see Switch product page.

Other accessories Page

- ^{b)} Access. for expl.-proof fans
- Flanged flexible connector**
STS 250 Ex Ref. no. 02501
- Flexible connecting sleeve**
FM 250 Ex Ref. no. 01688
- Extension sleeve for HS**
VH 250 Ref. no. 01343
- Cylindrical pipe section, galvanised steel, 15 cm long.
- Filter and silencers 481 ff.
- Shutters and ventilation grilles 561 ff.
- Speed controllers, controllers and switches 599 ff.

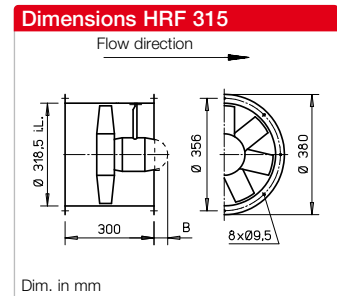
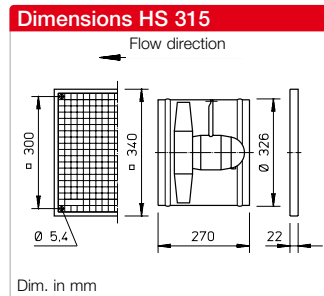
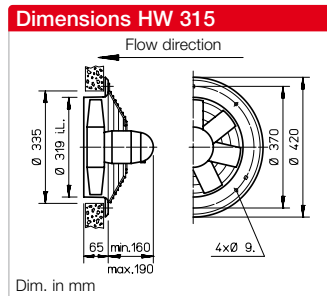
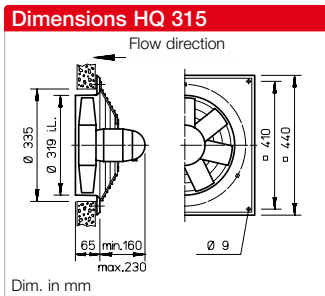

Description for all types

Casing

Made of galvanised steel sheet, types HQ and HW have additional two layer lacquer coating in papyrus white. Explosion-proof types have no lacquer coating.

Impeller

High performance characteristics with profiled blades made of plastic, dynamically balanced. Different for explosion-proof types.

Drive

Closed die-cast aluminium casing. Prot. cat. IP55. Ball bearing mounted. Maintenance-free and radio interference-free. Winding with moisture proof coating. See type table for max. air flow temperature. Different for explosion-proof types.

Motor protection

All types (except for 3~ explosion-proof, see page 180) are equipped with thermal contacts. These should be wired with the motor protection circuit breaker (see type table) for effective motor protection.

For types H..W 315/6 and all 1~ explosion-proof fans, the thermal contacts are wired in series with the winding, automatic deactivation and reactivation after cool down.

Electrical connection

Standard terminal box (IP55) on back of motor. Additionally on outside of duct for HRF types. Different for explosion-proof types.

Protection grille

Made of powder-coated steel for HQ/HW (HQ Ex galvanised), and plastic for HS. In accordance with DIN EN ISO 13857.

Power control

The voltage-controllable types are identified in the "Current consumption max. with control" column with a value which must be observed when determining the controller (see speed controller column). Possible assignments of frequency inverters to fans are shown in the type table. The flow rates are shown in the performance diagram.

Reverse operation

All types are reversible using a reverser switch. Performance reduction of approx. 1/3 in abnormal flow direction.

Installation

Installation possible in any position, but be aware of any condensate drain holes depending on usage.

Dimensions

Pole-changeable and explosion-proof types may differ from the above information.

Noise levels

See performance diagram. The sound power and sound pressure at 4 m distance under free field conditions are specified for the average operating point on the inlet/outlet side. See page 14 f for noise emissions and room acoustics. Different for explosion-proof types.

Speed	Flow rate free-blowing	Power consump.	Current consump.		Wiring diagram	Max. air flow temp.		Weight net aprx.	Design type							
			at rated voltage	max. with control		at rated voltage	with control		HQ incl. protection grille	Ref. no.	HW incl. protection grille	Ref. no.	HS incl. protection grille	Ref. no.	HRF	Ref. no.
min ⁻¹	V m ³ /h	W	A	A	No.	+ °C	+ °C	kg								
Single-phase alternating current, 230 Volt, 50 Hz, Capacitor motor, protection category IP55																
920	1330	33	0.25	0.35	317 ¹⁾	60	40	9.0	HQW 315/6	01105	—	—	HSW 315/6	00142	HRFW 315/6 ¹⁾	00202
1390	2080	104	0.45	0.47	475 ¹⁾	60	40	8.0	HQW 315/4	01106	HWW 315/4	01004	HSW 315/4	00143	HRFW 315/4 ²⁾	00203
Three-phase current, 400 Volt, 50 Hz, Squirrel-cage rotor, protection category IP55																
950	1370	68	0.27	0.32	469	60	40	9.0	HQD 315/6	01117	—	—	—	—	—	—
1330	1960	84	0.24	0.26	469	60	40	9.0	HQD 315/4	01118	HWD 315/4	01019	HSD 315/4	00158	HRFD 315/4	00223
2760	4080	527	1.10	1.23	469	50	40	11.0	HQD 315/2	01119	HWD 315/2	01020	—	—	HRFD 315/2	00224
Two-speed, three-phase current, 400 V, 50 Hz, √3 connection, protection category IP55																
1040/1280	1530/1980	56/87	0.11/0.22	—	520	60	—	10.5	HQD 315/4/4	01460	—	—	—	—	HRFD 315/4/4	01462
Pole-changeable, 2 speeds, three-phase current, Dahlander winding, 400 Volt, 50 Hz, protection category IP55																
720/1445	980/2060	49/115	0.20/0.43	—	472	60	—	12.0	HQD 315/8/4	01129	—	—	HSD 315/8/4	00346	HRFD 315/8/4	00391
1445/2845	2100/4190	106/558	0.45/1.32	—	472	50	—	12.5	HQD 315/4/2	01131	—	—	HSD 315/4/2	00348	HRFD 315/4/2	00393
		Explosion-proof, II 2G Ex h IIB T3 Gb, Motor Ex d, alternating current 230 Volt, 50 Hz, protection category IP55														
1370	2070	60*	1.25*	—	757	40	—	13.0	HQW 315/4 Ex	00442	—	—	—	—	HRFW 315/4 Ex	00439
		Explosion-proof, II 2G Ex h IIB + H₂ T3 Gb, Motor Ex e, three-phase current 400 Volt, 50 Hz, protection category IP55														
920	1400	250*	0.97*	—	470	40	—	23.0	HQD 315/6 Ex	01098	—	—	—	—	—	—
1350	2140	120*	0.37*	—	470	40	—	14.0	HQD 315/4 Ex	01147	—	—	—	—	HRFD 315/4 Ex	00473
2770	4130	550*	1.43*	—	470	40	—	16.5	HQD 315/2 Ex	01148	—	—	—	—	HRFD 315/2 Ex	00474

* Motor ratings, Ex see information on page 20. protection circuit breaker.

¹⁾ Type HRFW../6: Connection according to wiring diagram no. 963. ²⁾ Type HRFW../4: Connection according to wiring diagram no. 965.

³⁾ Incl. motor

Performance curves 315/2

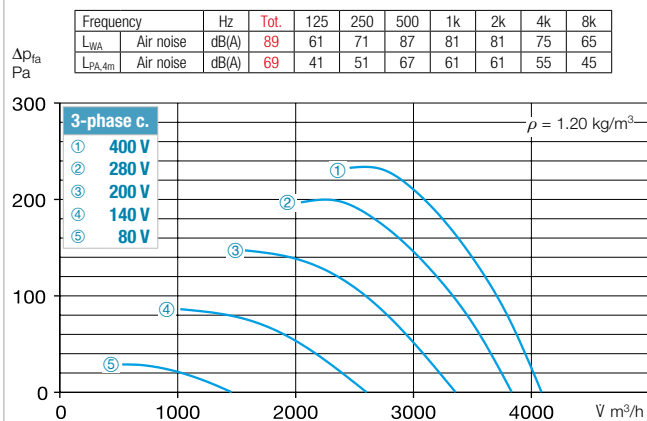

Performance curves 315/4

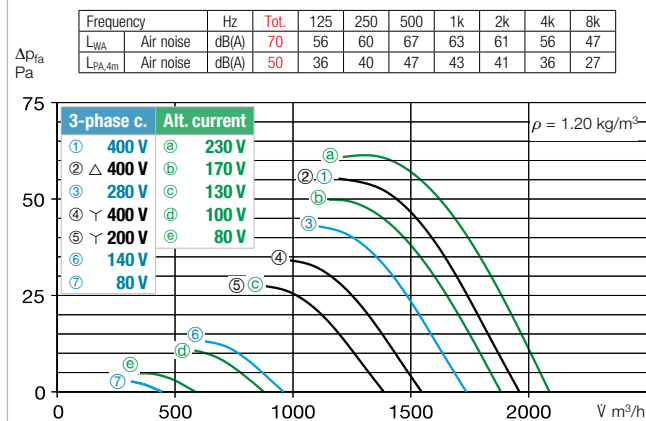

Performance curves 315/6

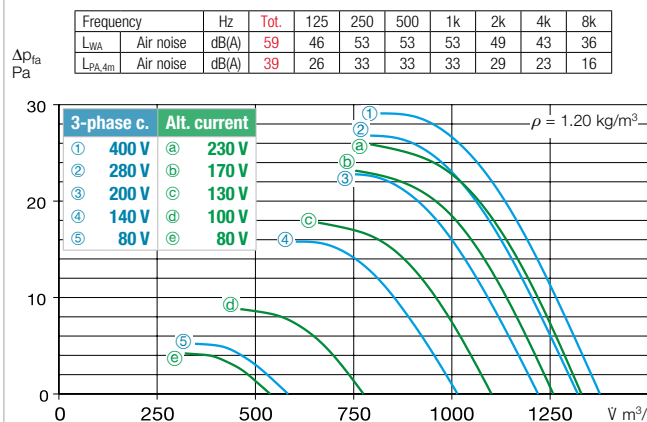

Performance curve 315/8

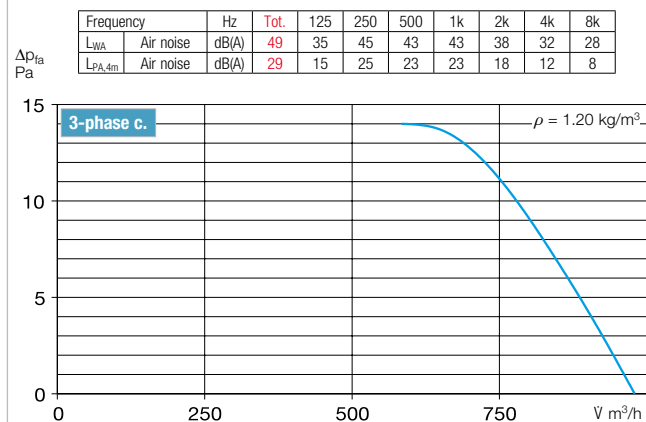

Accessories for HRF 315 Description see page 276 ff.

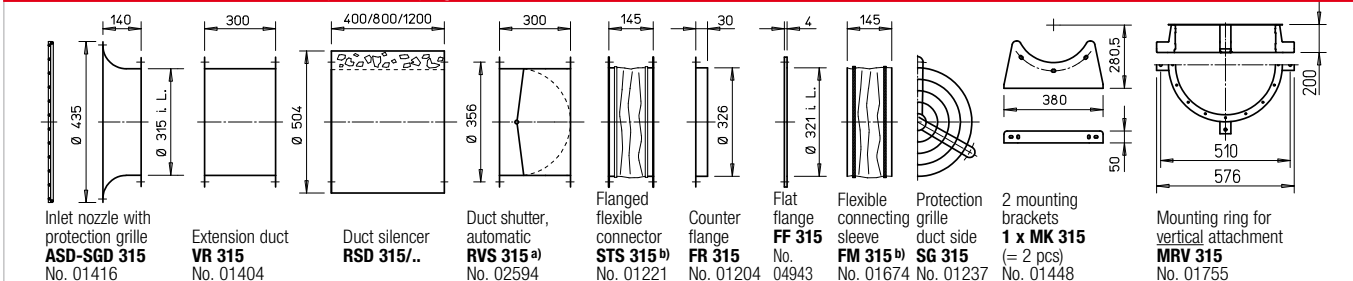

^{a)} Shutter, motorised see Accessories product pages.

^{b)} See below for types for explosion-proof fans.

Frequency inverter with integrated sine filter		Transformer speed controller 5-step, pole changing switch		Electronic speed controller, continuously variable flush-m./surface-m.		Motor protection circuit breaker for connecting built-in thermal contacts		Reverser switch	
Type	Ref. no.	Type	Ref. no.	Type	Ref. no.	Type	Ref. no.	Type	Ref. no.
—	—	TSW 0.3	03608	ESU 1/ESA 1	00236/00238	—	—	WS	01271
—	—	MWS 1.5 ³⁾	01947	ESU 1/ESA 1	00236/00238	MW	01579	WS	01271
FU-BS 2.5 ³⁾	05459	RDS 1 ³⁾	01314	—	—	MD	05849	WS	01271
FU-BS 2.5 ³⁾	05459	RDS 1 ³⁾	01314	—	—	MD	05849	WS	01271
FU-BS 2.5 ³⁾	05459	RDS 2 ³⁾	01315	EDS 5	00501	MD	05849	WS	01271
Speed changeover switch									
FU-BS 2.5 ³⁾	05459	DS2	01351	—	—	M 4 ⁴⁾ / MD	01571/05849	WS	01271
Pole changing switch									
—	—	PDA 12 ⁵⁾	05081	—	—	M 3 ⁴⁾	01293	PWDA	01282
—	—	PDA 12 ⁵⁾	05081	—	—	M 3 ⁴⁾	01293	PWDA	01282
—	—	not permitted	not permitted	not permitted	not permitted	—	—	—	—
—	—	not permitted	not permitted	not permitted	not permitted	—	—	—	—
—	—	not permitted	not permitted	not permitted	not permitted	—	—	—	—
—	—	not permitted	not permitted	not permitted	not permitted	—	—	—	—

⁴⁾ Incl. speed pole changing switch. ⁵⁾ Flush-m. version see Switch product page.

Other accessories Page

- ^{b)} Access. for expl.-proof fans
- Flanged flexible connector STS 315 Ex Ref. no. 02503
- Flexible connecting sleeve FM 315 Ex Ref. no. 01690
- Extension sleeve for HS VH 315 Ref. no. 01344
- Cylindrical pipe section, galvanised steel, 15 cm long.
- Filter and silencers 481 ff.
- Shutters and ventilation grilles 561 ff.
- Speed controllers, controllers and switches 599 ff.

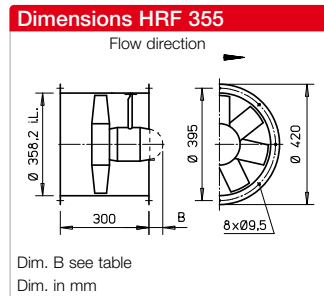
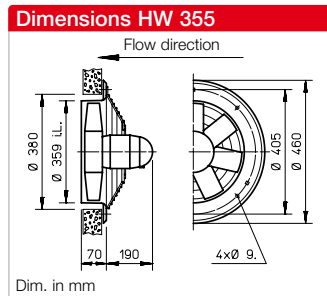
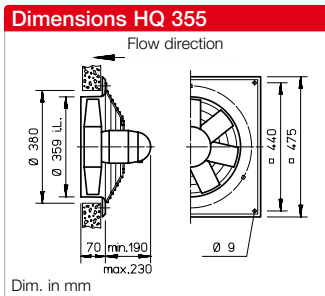

Description for all types

■ **Casing**

Made of galvanised steel sheet, types HQ and HW have additional two layer lacquer coating in papyrus white. Explosion-proof types have no lacquer coating.

■ **Impeller**

High performance characteristics with profiled blades made of plastic, dynamically balanced. Different for explosion-proof types.

■ **Drive**

Closed die-cast aluminium casing. Prot. cat. IP55. Ball bearing mounted. Maintenance-free and radio interference-free. Winding with moisture proof coating. See type table for max. air flow temperature. Different for explosion-proof types.

■ **Motor protection**

All types (except for 3~ explosion-proof, see page 180) are equipped with thermal contacts. These should be wired with the motor protection circuit breaker (see type table) for effective motor protection. For 1~ explosion-proof fans, the thermal contacts are wired in series with the winding, automatic deactivation and reactivation after cool down.

■ **Electrical connection**

Standard terminal box (IP55) on back of motor. Additionally on outside of duct for HRF types. Different for explosion-proof types.

■ **Protection grille**

Made of powder-coated steel for HQ and HW (HQ Ex galvanised). In accordance with DIN EN ISO 13857.

■ **Power control**

The voltage-controllable types are identified in the "Current consumption max. with control" column with a value which must be observed when determining the controller (see speed controller column). Possible assignments of frequency inverters to fans are shown in the performance diagram. The flow rates are shown in the performance diagram.

■ **Reverse operation**

All types are reversible using a reverser switch. Performance reduction of approx. 1/3 in abnormal flow direction.

■ **Installation**

Installation possible in any position, but be aware of any condensate drain holes depending on usage.

■ **Dimensions**

Pole-changeable and explosion-proof types may differ from the above information.

■ **Noise levels**

See performance diagram. The sound power and sound pressure at 4 m distance under free field conditions are specified for the average operating point on the inlet/outlet side. See page 14 f for noise emissions and room acoustics. Different for explosion-proof types.

Speed min ⁻¹	Flow rate free-blowing V m ³ /h	Power consump. W	Current consump.		Wiring diagram No.	Max. air flow temp.		Weight net aprx. kg	Design type							
			at rated voltage A	max. with control A		at rated voltage + °C	with control + °C		HQ incl. protection grille	Ref. no.	HW incl. protection grille	Ref. no.	HRF	Ref. no.	Dim. B Motor protrusion in mm	
Single-phase alternating current, 230 Volt, 50 Hz, Capacitor motor, protection category IP55																
960	1940	75	0.47	0.47	475 ¹⁾	60	40	12	HQW 355/6	01107	—	—	HRFW 355/6 ¹⁾	00204	—	
1345	2850	130	0.60	0.65	475 ¹⁾	60	40	11	HQW 355/4	01108	HWW 355/4	01006	HRFW 355/4 ¹⁾	00205	10	
Three-phase current, 400 Volt, 50 Hz, Squirrel-cage rotor, protection category IP55																
960	1970	70	0.27	0.29	469	60	40	9.5	HQD 355/6	01120	—	—	—	—		
1375	2900	130	0.35	0.35	469	60	40	11.0	HQD 355/4	01121	HWD 355/4	01022	HRFD 355/4	00226	—	
2670	5710	825	1.60	1.60	469	60	40	15.0	HQD 355/2	01122	HWD 355/2	01023	HRFD 355/2	00227	—	
Two-speed, three-phase current, 400 V, 50 Hz, γ/Δ connection, protection category IP55																
1120/1350	2460/2860	90/132	0.17/0.32	—	520	60	—	11.0	HQD 355/4/4	01463	—	—	HRFD 355/4/4	01464	—	
Pole-changeable, 2 speeds, three-phase current, Dahlander winding, 400 Volt, 50 Hz, protection category IP55																
700/1395	1430/2920	45/145	0.14/0.35	—	472	60	—	11.0	HQD 355/8/4	01132	—	—	HRFD 355/8/4	00394	10	
1430/2840	3050/6150	250/950*	0.63/2.30*	—	472	40	—	16.0	HQD 355/4/2	01134	—	—	HRFD 355/4/2	00396	35	
Ex	Explosion-proof, II 2G Ex h IIB T3 Gb, Motor Ex d, alternating current 230 Volt, 50 Hz, protection category IP55															
1370	2940	180*	1.25*	—	757	40	—	18.0	HQW 355/4 Ex	00444	—	—	HRFW 355/4 Ex	00443	30	
Ex	Explosion-proof, II 2G Ex h IIB + H₂ T3 Gb, Motor Ex e, three-phase current 400 Volt, 50 Hz, protection category IP55															
920	2010	250*	0.97*	—	470	40	—	25.0	HQD 355/6 Ex	01101	—	—	—	—	—	
1350	3060	120*	0.37*	—	470	40	—	18.0	HQD 355/4 Ex	01150	—	—	HRFD 355/4 Ex	00476	—	
2830	5910	1100*	2.60*	—	470	40	—	12.5	HQD 355/2 Ex	01151	—	—	HRFD 355/2 Ex	00477	—	

* Motor ratings, Ex see information on page 20.

¹⁾ Type HRFW: Connection according to wiring diagram no. 965.

²⁾ Incl. motor protection circuit breaker.

³⁾ Incl. speed pole changing switch.

Performance curves 355/2

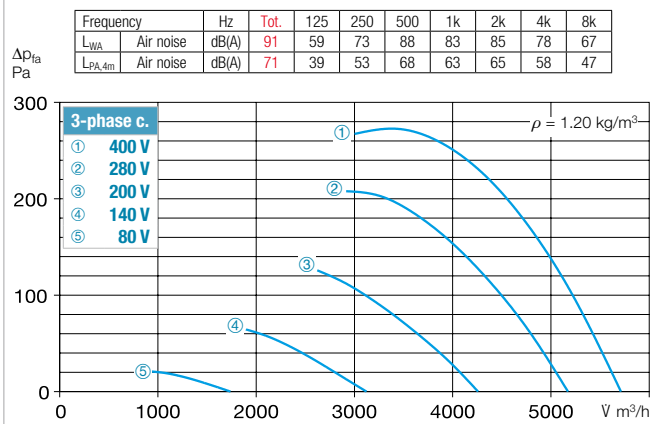

Performance curves 355/4

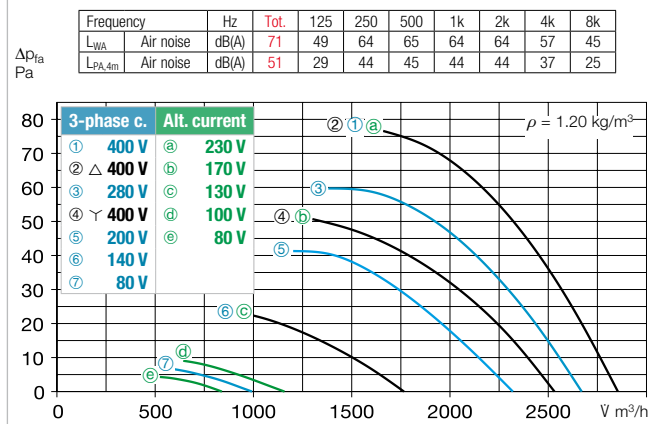

Performance curves 355/6

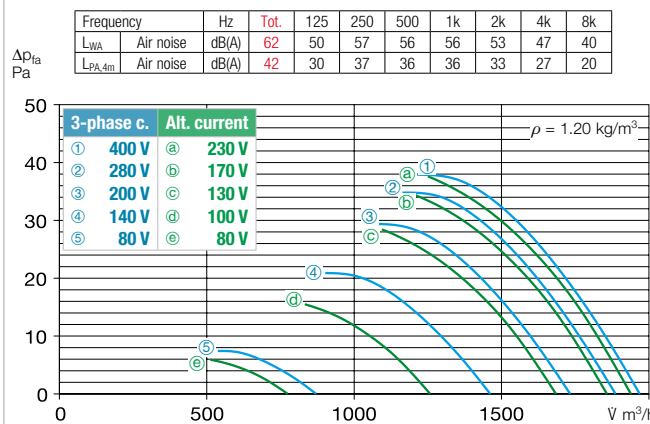

Performance curve 355/8

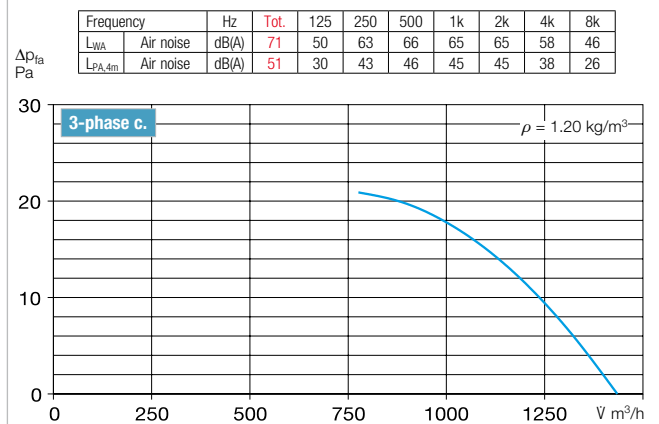

Accessories for HRF 355 Description see page 276 ff.

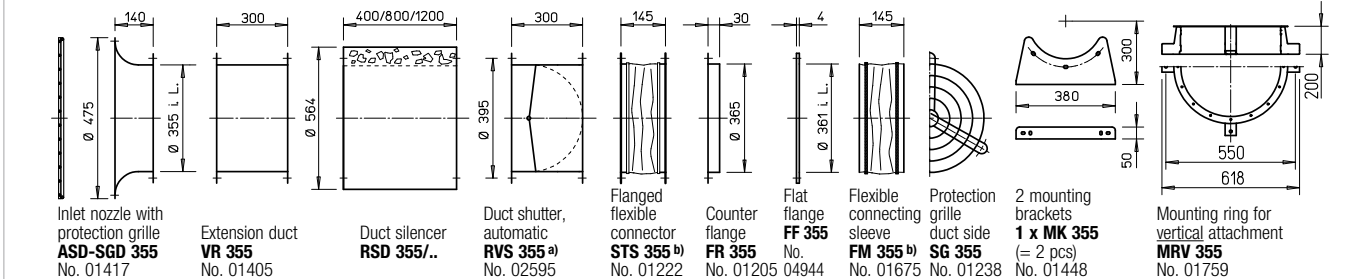

a) Shutter, motorised see Accessories product pages.

b) See below for types for explosion-proof fans.

Frequency inverter with integrated sine filter	Transformer speed controller 5-step, pole changing switch	Electronic speed controller, continuously variable flush-m./surface-m.	Motor protection circuit breaker for connecting built-in thermal contacts	Reverser switch	
Type	Ref. no.	Type	Ref. no.	Type	Ref. no.
—	MWS 1.5 ²⁾ 01947	ESU 1/ESA 1 00236/00238	MW 01579	WS 01271	
—	MWS 1.5 ²⁾ 01947	ESU 1/ESA 1 00236/00238	MW 01579	WS 01271	
FU-BS 2.5 ²⁾ 05459	RDS 1 ²⁾ 01314	—	MD 05849	WS 01271	
FU-BS 2.5 ²⁾ 05459	RDS 1 ²⁾ 01314	—	MD 05849	WS 01271	
FU-BS 2.5 ²⁾ 05459	RDS 2 ²⁾ 01315	ESD 5 00501	MD 05849	WS 01271	
—	Speed changeover switch DS 2 01351	—	M 4 ³⁾ /MD 01571/05849	WS 01271	
—	Pole changing switch PDA 12 ⁴⁾ 05081	—	M 3 ³⁾ 01293	PWDA 01282	
—	PDA 12 ⁴⁾ 05081	—	MSA 01289	PWDA 01282	
—	not permitted	not permitted	—	—	
—	not permitted	not permitted	—	—	
—	not permitted	not permitted	—	—	
—	not permitted	not permitted	—	—	

4) Flush-m. version see Switch product page.

Other accessories Page

- b) Access. for expl.-proof fans
- Flanged flexible connector**
 STS 355 Ex Ref. no. 02504
- Flexible connecting sleeve**
 FM 355 Ex Ref. no. 01691
- Extension sleeve for HS**
 VH 355 Ref. no. 01345
- Cylindrical pipe section, galvanised steel, 15 cm long.
- Filter and silencers 481 ff.
- Shutters and ventilation grilles 561 ff.
- Speed controllers, controllers and switches 599 ff.

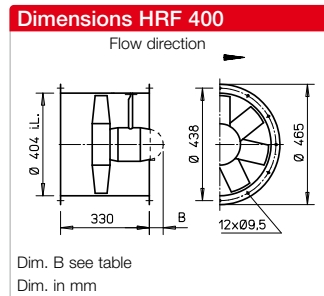
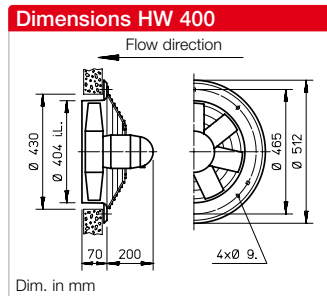
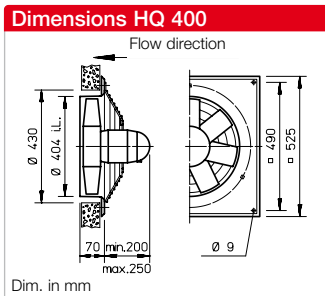

Description for all types

Casing

Made of galvanised steel sheet, types HQ and HW have additional two layer lacquer coating in papyrus white. Explosion-proof types have no lacquer coating

Impeller

High performance characteristics with profiled blades made of plastic, dynamically balanced. Different for explosion-proof types.

Drive

Closed die-cast aluminium casing. Prot. cat. IP55. Ball bearing mounted. Maintenance-free and radio interference-free. Winding with moisture proof coating. See type table for max. air flow temperature. Different for explosion-proof types.

Motor protection

All types (except for explosion-proof, see page 180) are equipped with thermal contacts. These should be wired with the motor protection circuit breaker (see type table) for effective motor protection.

Electrical connection

Standard terminal box (IP55) on back of motor. Additionally on outside of duct for HRF types. Different for explosion-proof types.

Protection grille

Made of powder-coated steel for HQ and HW (HQ Ex galvanised). In accordance with DIN EN ISO 13857.

Power control

The voltage-controllable types are identified in the "Current consumption max. with control" column with a value which must be observed when determining

the controller (see speed controller column). Possible assignments of frequency inverters to fans are shown in the type table. The planned use of a frequency inverter without a sine filter should be indicated when placing the order. This requires a change of fan version and additional costs, if necessary. The flow rates are shown in the perform. diagram.

Reverse operation

All types are reversible using a reverser switch. Performance reduction of approx. 1/3 in abnormal flow direction.

Installation

Installation possible in any position, but be aware of any condensate drain holes depending on usage.

Dimensions

Pole-changeable and explosion-proof types may differ from the above information.

Noise levels

See performance diagram. The sound power and sound pressure at 4 m distance under free field conditions are specified for the average operating point on the inlet/outlet side. See page 14 f for noise emissions and room acoustics. Different for explosion-proof types.

Reference	Page
Techn. description	180
Selection table	181
Planning information	14 ff.
Special design	
Different voltage, protection category, air flow direction, higher air flow temperature, acid protection and impeller in other materials upon request.	
The technical information on p. 19 ff. must be observed.	

Speed min ⁻¹	Flow rate free-blowing V m ³ /h	Power consump. W	Current consump.		Wiring diagram No.	Max. air flow temp.		Weight net aprx. kg	Design type						
			at rated voltage A	max. with control A		at rated voltage + °C	with control + °C		HQ incl. protection grille	Ref. no.	HW incl. protection grille	Ref. no.	HRF	Ref. no.	Dim. B Motor protrusion in mm
Single-phase alternating current, 230 Volt, 50 Hz, Capacitor motor, protection category IP55															
930	2570	77	0.52	0.54	475 ¹⁾	60	40	13.0	HQW 400/6	01110	—	—	HRFW 400/6 ¹⁾	00206	—
1350	4010	235	1.00	1.10	475 ¹⁾	60	40	14.0	HQW 400/4	01111	HWW 400/4	01008	HRFW 400/4 ¹⁾	00207	10
Three-phase current, 400 Volt, 50 Hz, Squirrel-cage rotor, protection category IP55															
950	2620	89	0.28	0.30	469	60	40	13.0	HQD 400/6	01123	—	—	—	—	—
1330	3960	200	0.40	0.40	469	60	40	14.0	HQD 400/4	01124	HWD 400/4	01025	HRFD 400/4	00229	—
Two-speed, three-phase current, 400 V, 50 Hz, γ/Δ connection, protection category IP55															
1325/1085	3170/3920	135/205	0.25/0.45	0.45	520	60	40	20.0	HQD 400/4/4	01465	—	—	HRFD 400/4/4	01466	—
2890/2600	7890/8400	1300/2310*	3.00/5.60*	4.70	520	60	40	25.0	HQD 400/2/2	01475	—	—	HRFD 400/2/2	01474	120
Pole-changeable, 2 speeds, three-phase current, Dahlander winding, 400 Volt, 50 Hz, protection category IP55															
690/1390	2010/4100	70/250	0.25/0.60	—	472	60	—	13.0	HQD 400/8/4	01137	—	—	HRFD 400/8/4	00399	10
1480/2940	4180/8540	300/2310*	1.00/5.20*	—	472	40	—	24.0	HQD 400/4/2	01139	—	—	HRFD 400/4/2	00401	120
 Ex Explosion-proof, II 2G Ex h IIB + H₂ T3 Gb, Motor Ex e, three-phase current 400 Volt, 50 Hz, protection category IP55															
920	2870	250*	0.97*	—	470	40	—	13.0	HQD 400/6 Ex	01109	—	—	—	—	—
1370	4380	370*	1.08*	—	470	40	—	16.0	HQD 400/4 Ex	01153	—	—	HRFD 400/4 Ex	00479	—

* Motor ratings, Ex see information on page 20. ¹⁾ Type HRFW: Connection according to wiring diagram no. 965 ²⁾ Incl. motor protection circuit breaker. ³⁾ Incl. speed pole changing switch.

Performance curves 400/2

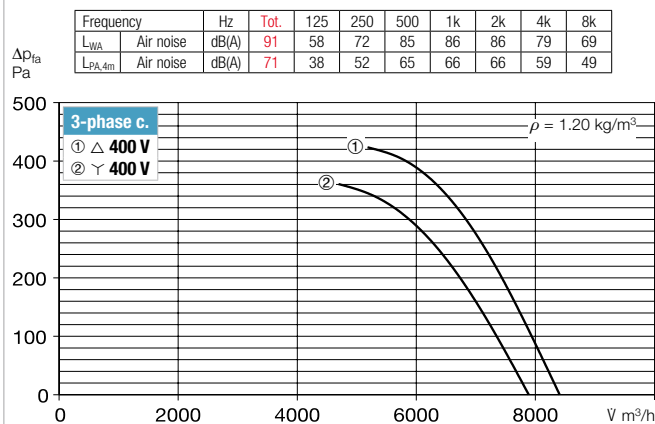

Performance curves 400/4

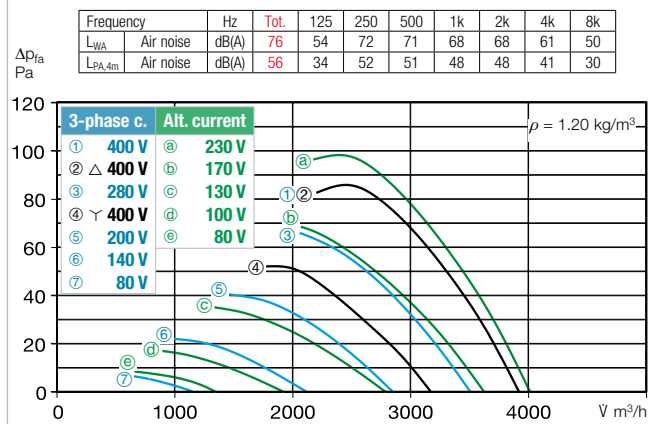

Performance curves 400/6

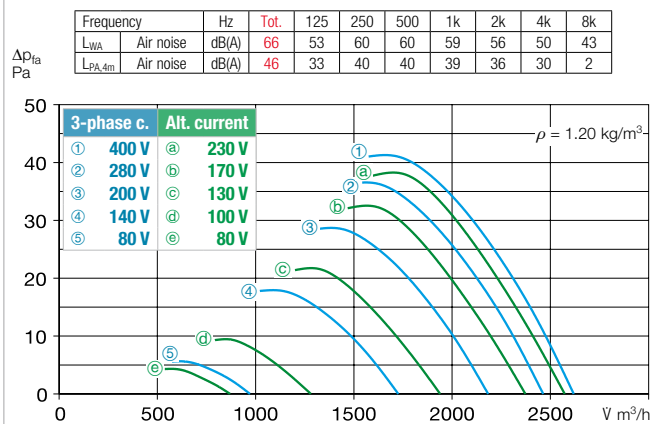

Performance curve 400/8

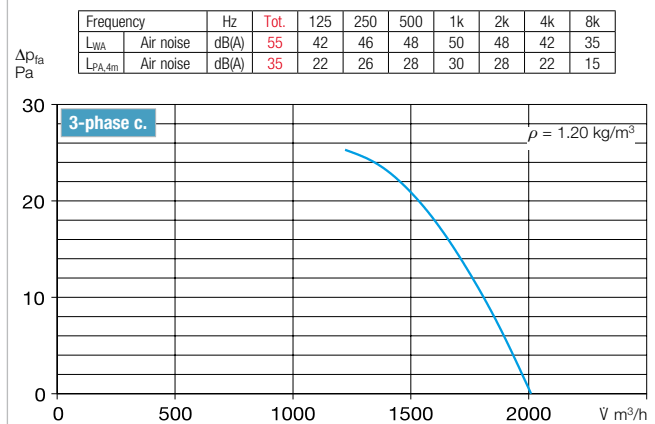

Accessories for HRF 400 Description see page 276 ff.

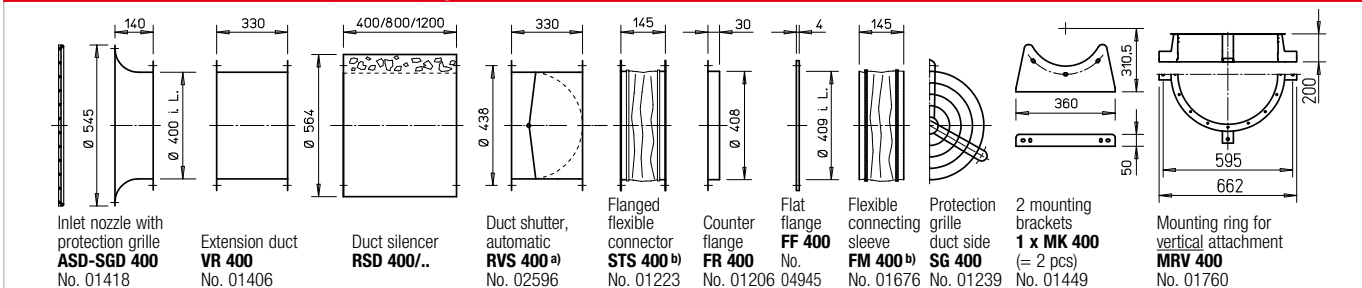

^{a)} Shutter, motorised see Accessories product pages.

^{b)} See below for types for explosion-proof fans.

Frequency inverter with integrated sine filter		Transformer speed controller 5-step, pole changing switch		Electronic speed controller, continuously variable flush-m./surface-m.		Motor protection circuit breaker for connecting built-in thermal contacts		Reverser switch	
Type	Ref. no.	Type	Ref. no.	Type	Ref. no.	Type	Ref. no.	Type	Ref. no.
—	—	MWS 1.5 ²⁾	01947	ESU 1/ESA 1	00236/00238	MW	01579	WS	01271
—	—	MWS 1.5 ²⁾	01947	ESU 1/ESA 1	00236/00238	MW	01579	WS	01271
FU-BS 2.5 ²⁾	05459	RDS 1 ²⁾	01314	—	—	MD	05849	WS	01271
FU-BS 2.5 ²⁾	05459	RDS 1 ²⁾	01314	—	—	MD	05849	WS	01271
Speed changeover switch									
FU-BS 2.5 ²⁾	05459	RDS 1 ²⁾	01314	—	—	M 4 ³⁾ /MD	01571/05849	WS	01271
FU-BS 5.0 ²⁾	05460	DS 2	01351	ESD 5 ²⁾	00501	M 4 ³⁾ /MD	01571/05849	WS	01271
Pole changing switch									
—	—	PDA 12 ⁴⁾	05081	—	—	M 3 ³⁾	01293	PWDA	01282
—	—	PDA 12 ⁴⁾	05081	—	—	M 3 ³⁾	01293	PWDA	01282
—	—	not permitted	—	not permitted	—	—	—	—	—
—	—	not permitted	—	not permitted	—	—	—	—	—

⁴⁾ Flush-m. version see Switch product page.

Other accessories Page

- ^{b)} Access. for expl.-proof fans
- Flanged flexible connector STS 400 Ex Ref. no. 02505
- Flexible connecting sleeve FM 400 Ex Ref. no. 01692
- Extension sleeve for HS VH 400 Ref. no. 01346
- Cylindrical pipe section, galvanised steel, 15 cm long.
- Filter and silencers 481 ff.
- Shutters and ventilation grilles 561 ff.
- Speed controllers, controllers and switches 599 ff.

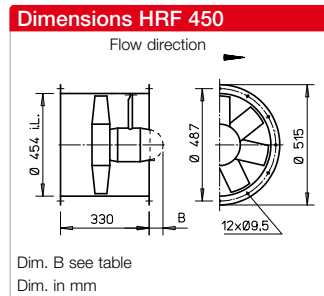
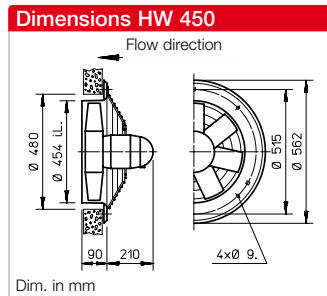
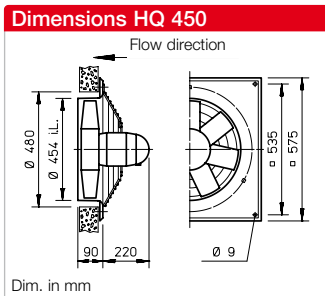

Description for all types

Casing

Made of galvanised steel sheet, types HQ and HW have additional two layer lacquer coating in papyrus white. Explosion-proof types have no lacquer coating

Impeller

High performance characteristics with profiled blades made of plastic, dynamically balanced. Different for explosion-proof types.

Drive

Closed die-cast aluminium casing. Prot. cat. IP55. Ball bearing mounted. Maintenance-free and radio interference-free. Winding with moisture proof coating. See type table for max. air flow temperature. Different for explosion-proof types.

Motor protection

All types (except for explosion-proof, see page 180) are equipped with thermal contacts. These should be wired with the motor protection circuit breaker (see type table) for effective motor protection.

Electrical connection

Standard terminal box (IP55) on back of motor. Additionally on outside of duct for HRF types. Different for explosion-proof types.

Protection grille

Made of powder-coated steel for HQ and HW (HQ Ex galvanised). In accordance with DIN EN ISO 13857.

Power control

The voltage-controllable types are identified in the "Current consumption max. with control" column with a value which must be observed when determining the controller (see speed controller column). Possible assignments of frequency inverters to fans are shown in the type table. The planned use of a frequency inverter without a sine filter should be indicated when placing the order. This requires a change of fan version and additional costs, if necessary. The flow rates are shown in the performance diagram.

Reverse operation

All types are reversible using a reverser switch. Performance reduction of approx. 1/3 in abnormal flow direction.

Installation

Installation possible in any position, but be aware of any condensate drain holes depending on usage.

Dimensions

Pole-changeable and explosion-proof types may differ from the above information.

Noise levels

See performance diagram. The sound power and sound pressure at 4 m distance under free field conditions are specified for the average operating point on the inlet/outlet side. See page 14 f for noise emissions and room acoustics. Different for explosion-proof types.

Speed min ⁻¹	Flow rate free-blowing V m ³ /h	Power consump. W	Current consump.		Wiring diagram No.	Max. air flow temp.		Weight net aprx. kg	Design type															
			at rated voltage A	max. with control A		at rated voltage + °C	with control + °C		HQ incl. protection grille	Ref. no.	HW incl. protection grille	Ref. no.	HRF	Ref. no.	Dim. B Motor protrusion in mm									
Single-phase alternating current, 230 Volt, 50 Hz, Capacitor motor, protection category IP55																								
915	3890	136	0.63	0.63	475 ¹⁾	60	40	19.0	HQW 450/6	00991	—	—	HRFW 450/6 ¹⁾	00208	—									
1380	5770	405	1.76	2.02	475 ¹⁾	60	40	18.0	HQW 450/4	00992	HWW 450/4	01010	HRFW 450/4 ¹⁾	00209	—									
Three-phase current, 400 Volt, 50 Hz, Squirrel-cage rotor, protection category IP55																								
960	3920	137	0.38	0.42	469	60	40	18.0	HQD 450/6	00993	—	—	HRFD 450/6	00230	—									
1390	5810	384	0.81	0.92	469	50	40	17.0	HQD 450/4	00994	HWD 450/4	01028	HRFD 450/4	00231	—									
Two-speed, three-phase current, 400 V, 50 Hz, ∇/Δ connection, protection category IP55																								
1130/1390	5090/5780	280/378	0.51/0.82	—	520	60	—	22.0	HQD 450/4/4	01467	—	—	HRFD 450/4/4	01468	—									
2775/2200	10190/9335	1300/2310*	5.40/3.0*	5.10	520	40	40	32.0	—	—	—	—	HRFD 450/2/2	00484	150									
Pole-changeable, 2 speeds, three-phase current, Dahlander winding, 400 Volt, 50 Hz, protection category IP55																								
480/970	1930/3950	62/163	0.22/0.47	—	472	60	—	18.0	HQD 450/12/6	00995	—	—	—	—	—									
705/1410	2860/5810	91/404	0.36/0.92	—	472	50	—	20.0	HQD 450/8/4	00996	—	—	HRFD 450/8/4	00403	—									
Ex Explosion-proof, II 2G Ex h IIB + H₂ T3 Gb, Motor Ex e, three-phase current 400 Volt, 50 Hz, protection category IP55																								
920	4090	250*	0.97*	—	470	40	—	15.5	HQD 450/6 Ex	01473	—	—	—	—	—									
1370	6240	370*	1.08*	—	470	40	—	15.5	HQD 450/4 Ex	01154	—	—	HRFD 450/4 Ex	00481	—									

* Motor ratings, Ex see information on page 20. ¹⁾ Type HRFW: Connection according to wiring diagram no. 965. ²⁾ Incl. motor protection circuit breaker. ³⁾ Flush-m. version see Switch product page.

Performance curves 450/2

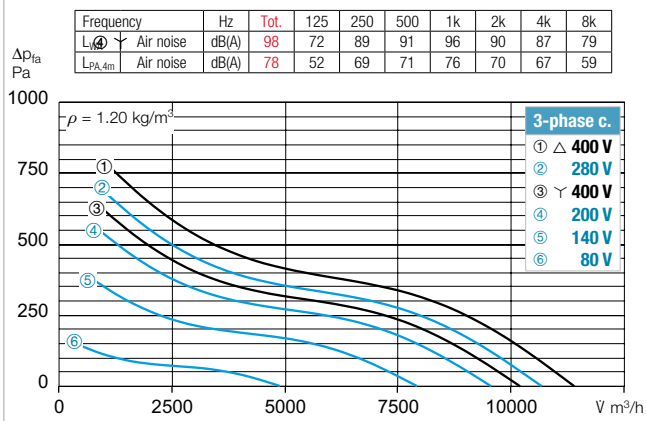

Performance curves 450/4

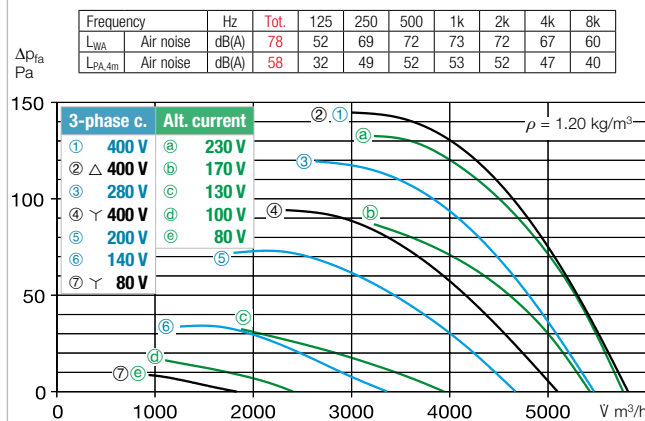

Performance curves 450/6

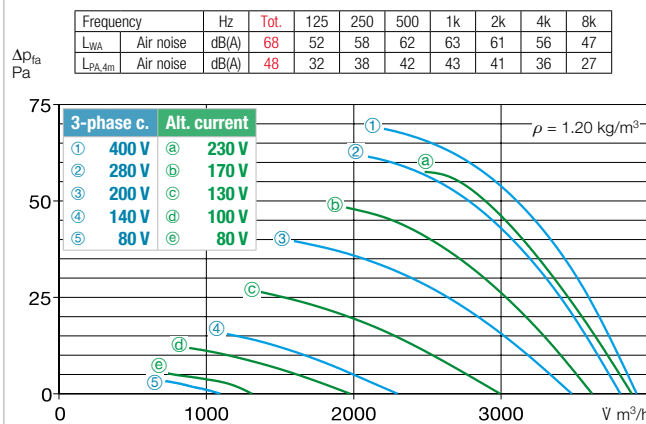

Performance curves 450/8

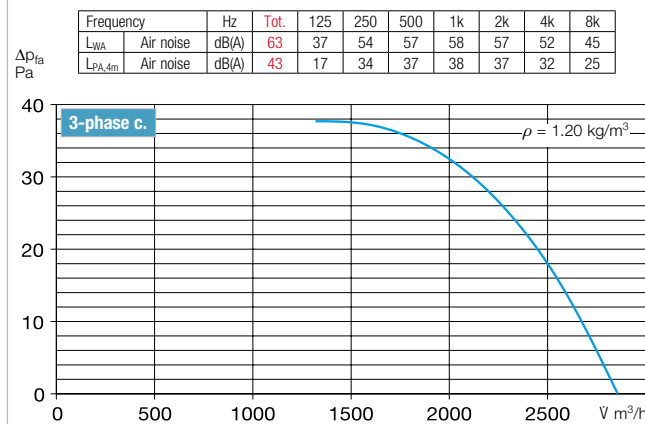

Accessories for HRF 450 Description see page 276 ff.

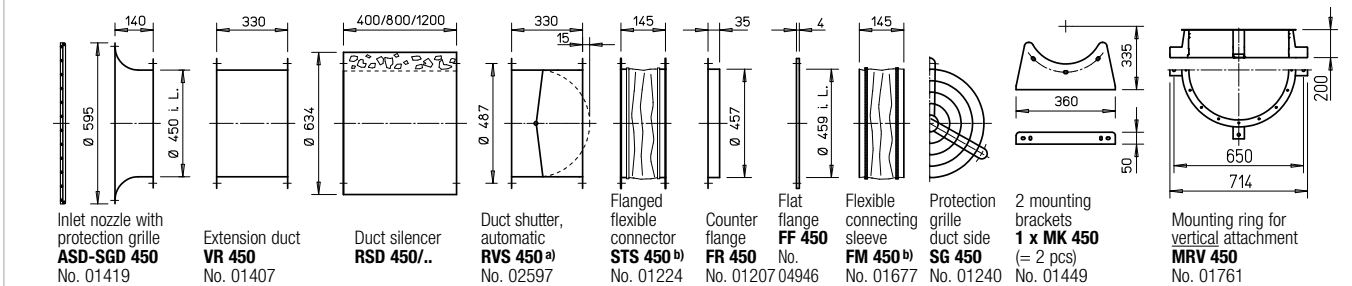

^{a)} Shutter, motorised see Accessories product pages.

^{b)} See below for types for explosion-proof fans.

Frequency inverter with integrated sine filter		Transformer speed controller 5-step, pole changing switch		Electronic speed controller, continuously variable flush-m./surface-m.		Motor protection circuit breaker for connecting built-in thermal contacts		Reverser switch	
Type	Ref. no.	Type	Ref. no.	Type	Ref. no.	Type	Ref. no.	Type	Ref. no.
—	—	MWS 1.5 ²⁾	01947	ESU 3/ESA 3	00237/00239	MW	01579	WS	01271
—	—	MWS 3 ²⁾	01948	ESU 3/ESA 3	00237/00239	MW	01579	WS	01271
FU-BS 2.5 ²⁾	05459	RDS 1 ²⁾	01314	—	—	MD	05849	WS	01271
FU-BS 2.5 ²⁾	05459	RDS 2 ²⁾	01315	EDS 5 ²⁾	00501	MD	05849	WS	01271
Speed changeover switch									
FU-BS 2.5 ²⁾	05459	DS 2 ⁵⁾	01351	—	—	M 4 ³⁾ /MD	01571/05849	WS	01271
FU-BS 8.0 ²⁾	05461	RDS 7 ²⁾	01578	ESD 11.5 ²⁾	00502	M 4 ³⁾ /MD	01571/05849	WS	01271
Pole changing switch									
—	—	PDA 12 ³⁾	05081	—	—	M 3 ⁴⁾	01293	PWDA	01282
—	—	PDA 12 ³⁾	05081	—	—	M 3 ⁴⁾	01293	PWDA	01282
—	—	not permitted	—	not permitted	—	—	—	—	—
—	—	not permitted	—	not permitted	—	—	—	—	—

⁴⁾ Incl. speed pole changing switch.

⁵⁾ Speed changeover switch.

Other accessories Page

^{b)} Access. for expl.-proof fans	
Flanged flexible connector STS 450 Ex	Ref. no. 02506
Flexible connecting sleeve FM 450 Ex	Ref. no. 01693
Filter and silencers	481 ff.
Shutters and ventilation grilles	561 ff.
Speed controllers, controllers and switches	599 ff.

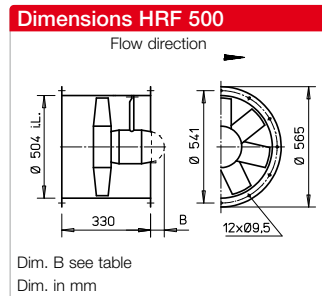
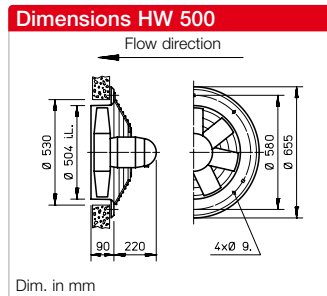
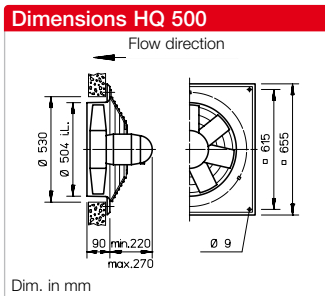

Description for all types

- **Casing**
 Made of galvanised steel sheet, types HQ and HW have additional two layer lacquer coating in papyrus white. Explosion-proof types have no lacquer coating
- **Impeller**
 High performance characteristics with profiled blades made of plastic, dynamically balanced. Different for explosion-proof types.
- **Drive**
 Closed die-cast aluminium casing. Prot. cat. IP55. Ball bearing mounted. Maintenance-free and radio interference-free. Winding with moisture proof coating. See type table for max. air flow temperature. Different for explosion-proof types.

- **Motor protection**
 All types (except for explosion-proof, see page 180) are equipped with thermal contacts. These should be wired with the motor protection circuit breaker (see type table) for effective motor protection.
- **Electrical connection**
 Standard terminal box (IP55) on back of motor. Additionally on outside of duct for HRF types. Different for explosion-proof types.
- **Protection grille**
 Made of powder-coated steel for HQ and HW (HQ Ex galvanised). In accordance with DIN EN ISO 13857.
- **Power control**
 The voltage-controllable types are identified in the "Current consumption max. with control"

column with a value which must be observed when determining the controller (see speed controller column). Possible assignments of frequency inverters to fans are shown in the type table. The planned use of a sine filter should be indicated when placing the order. This requires a change of fan version and additional costs, if necessary. The flow rates are shown in the performance diagram.

- **Reverse operation**
 All types are reversible using a reverser switch. Performance reduction of approx. 1/3 in abnormal flow direction.
- **Installation**
 Installation possible in any position, but be aware of any condensate drain holes depending on usage.

- **Dimensions**
 Pole-changeable and explosion-proof types may differ from the above information.
- **Noise levels**
 See performance diagram. The sound power and sound pressure at 4 m distance under free field conditions are specified for the average operating point on the inlet/outlet side. See page 14 f for noise emissions and room acoustics. Different for expl.-proof types.

Reference	Page
Techn. description	180
Selection table	181
Planning information	14 ff.

Special design
 Different voltage, protection category, air flow direction, higher air flow temperature, acid protection and impeller made of cast aluminium upon request.

Speed min ⁻¹	Flow rate free-blowing V m ³ /h	Power consump. W	Current consump.		Wiring diagram No.	Max. air flow temp.		Weight net aprx. kg	Design type						
			at rated voltage A	max. with control A		at rated voltage + °C	with control + °C		HQ incl. protection grille	Ref. no.	HW incl. protection grille	Ref. no.	HRF	Ref. no.	Dim. B Motor protrusion in mm
Single-phase alternating current, 230 Volt, 50 Hz, Capacitor motor, protection category IP55															
935	5500	233	1.05	1.25	475 ¹⁾	60	40	19.0	HQW 500/6	01112	—	—	HRFW 500/6 ¹⁾	00210	—
1375	8320	1100*	5.90*	4.94	475 ¹⁾	40	40	25.0	HQW 500/4	01113	—	—	HRFW 500/4 ¹⁾	00211	60
Three-phase current, 400 Volt, 50 Hz, Squirrel-cage rotor, protection category IP55															
920	5480	218	0.48	0.55	469	60	40	19.0	HQD 500/6	01126	—	—	HRFD 500/6	00232	—
1345	8200	620	1.22	1.32	469	40	40	19.5	HQD 500/4	01127	HWD 500/4	01030	HRFD 500/4	00233	—
Two-speed, three-phase current, 400 V, 50 Hz, Y/Δ connection, protection category IP55															
615/920	4330/5450	133/214	0.29/0.46	—	520	60	—	18.0	HQD 500/6/6	01471	—	—	—	—	—
1030/1350	6720/8150	416/617	0.76/1.19	—	520	60	—	24.0	HQD 500/4/4	01469	—	—	HRFD 500/4/4	01470	120
2450/2830	13615/12050	1960/2470*	3.14/4.73*	—	520	40	—	30.0	—	—	—	—	HRFD 500/2/2	00485	150
Pole-changeable, 2 speeds, three-phase current, Dahlander winding, 400 Volt, 50 Hz, protection category IP55															
465/940	2680/5490	71/248	0.23/0.56	—	472	60	—	18.0	HQD 500/12/6	01140	—	—	—	—	—
700/1385	3890/8280	137/688	0.52/1.48	—	472	40	—	22.0	HQD 500/8/4	01142	—	—	HRFD 500/8/4	00407	—
Ex Ex Explosion-proof, II 2G Ex h IIB + H₂ T3 Gb, Motor Ex e, three-phase current 400 Volt, 50 Hz, protection category IP55															
920	5610	250*	0.97*	—	470	40	—	18.0	HQD 500/6 Ex	01050	—	—	HRFD 500/6 Ex	00489	10
1390	8560	750*	2.00*	—	470	40	—	18.0	HQD 500/4 Ex	01157	—	—	HRFD 500/4 Ex	00483	45

* Motor ratings, Ex see information on page 20. ¹⁾ Type HRFW: Connection according to wiring diagram no. 965. ²⁾ Incl. motor protection circuit breaker. ³⁾ Incl. speed pole changing switch.

Performance curves 500/2

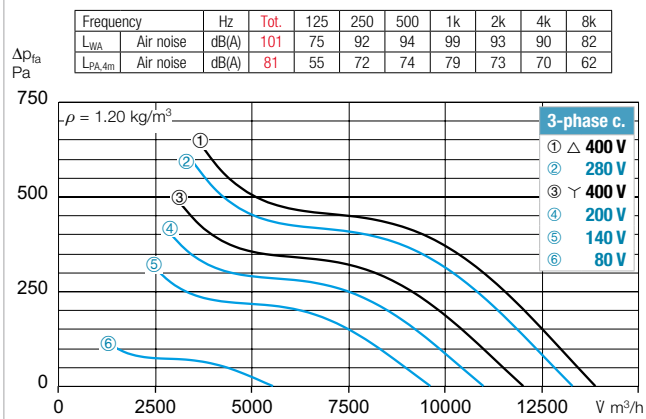

Performance curves 500/4

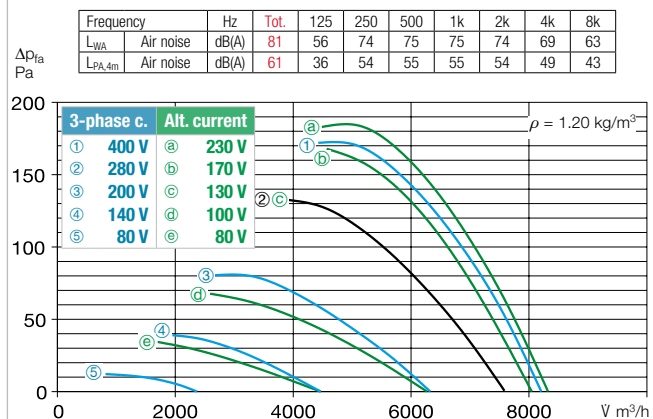

Performance curves 500/6

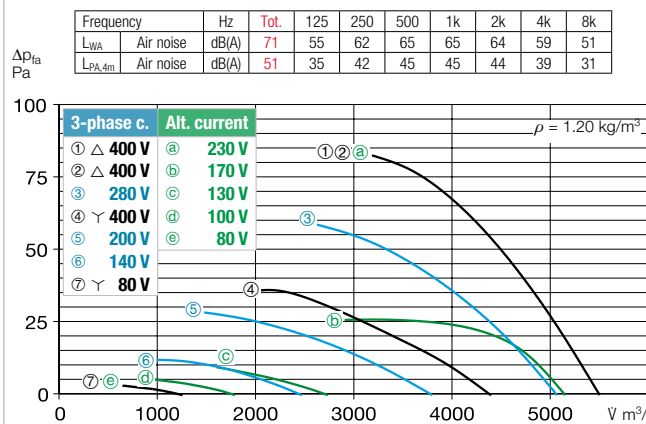

Performance curve 500/8

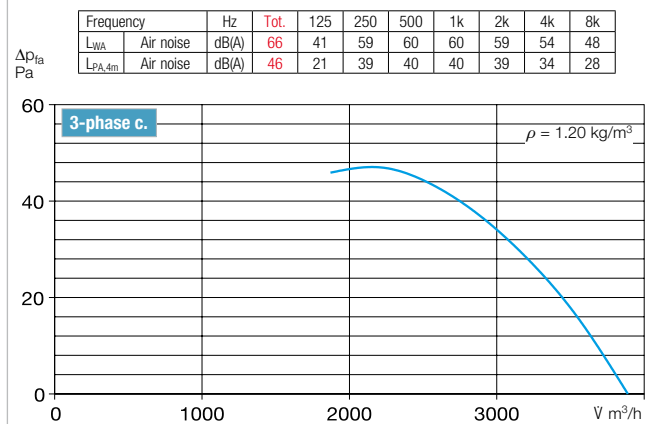

Accessories for HRF 500 Description see page 276 ff.

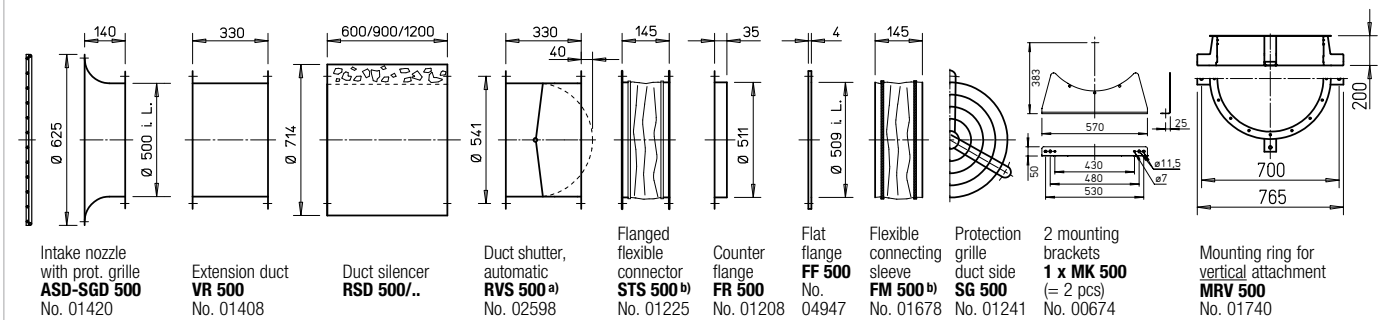

a) Shutter, motorised see Accessories product pages.

b) See below for types for explosion-proof fans.

Frequency inverter with integrated sine filter	Transformer speed controller 5-step, pole changing switch	Electronic speed controller, continuously variable flush-m./surface-m.	Motor protection circuit breaker for connecting built-in thermal contacts	Reverser switch					
Type	Ref. no.	Type	Ref. no.	Type	Ref. no.				
—	MWS 1.5 2)	01947	ESU 3/ESA 3	00237/00239	MW	01579	WS	01271	
—	MWS 5 2)	01949	ESU 5/ESA 5	01296/01299	MW	01579	WS	01271	
FU-BS 2.5 2)	05459	RDS 1 2)	01314	ESD 5 2)	00501	MD	05849	WS	01271
FU-BS 2.5 2)	05459	RDS 2 2)	01315	ESD 5 2)	00501	MD	05849	WS	01271
Speed changeover switch									
FU-BS 2.5 2)	05459	DS 2 5)	01351	—	M 4 4)/MD	01571/05849	WS	01271	
FU-BS 2.5 2)	05459	DS 2 5)	01351	ESD 5 2)	00501	M 4 4)/MD	01571/05849	WS	01271
FU-BS 5.0 2)	05460	RDS 7 2)	01578	ESD 11.5 2)	00502	M 4 4)/MD	01571/05849	WS	01271
Pole changing switch									
—	PDA 12 4)	05081	—	M 3 3)	01293	PWDA	01282		
—	PDA 12 4)	05081	—	M 3 3)	01293	PWDA	01282		
—	not permitted		not permitted	—	—	—	—		
—	not permitted		not permitted	—	—	—	—		

4) Flush-m. version see Switch product page. 5) Speed changeover switch.

Other accessories Page

- Access. for expl.-proof fans
- Flanged flexible connector
STS 500 Ex Ref. no. 02507
- Flexible connecting sleeve
FM 500 Ex Ref. no. 01694
- Extension sleeve for HS
VH 500 Ref. no. 01348
- Cylindrical pipe section, galvanised steel, 15 cm long.
- Filter and silencers 481 ff.
- Shutters and ventilation grilles 561 ff.
- Speed controllers, controllers and switches 599 ff.

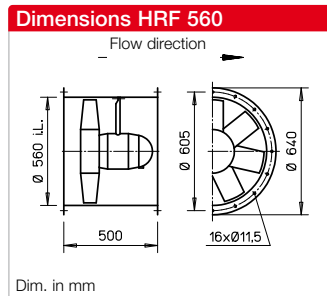
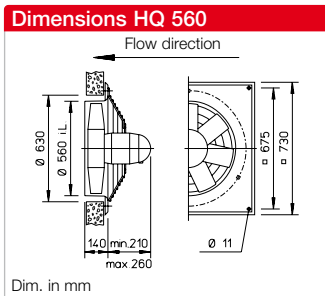

Description for all types

- Casing**
 Made of galvanised steel sheet. Type HQ has additional two layer lacquer coating in papyrus white. Explosion-proof types have no lacquer coating.
- Impeller**
 High performance characteristics with profiled blades made of plastic, dynamically balanced. Different for explosion-proof types.
- Drive**
 Closed die-cast aluminium casing. Protection category IP55. Ball bearing mounted. Maintenance-free and radio interference-free. Winding with moisture proof coating. See type table for max. air flow temperature. Different for explosion-proof types.

- Motor protection**
 All types (except for explosion-proof, see page 180) are equipped with thermal contacts. These should be wired with the motor protection circuit breaker (see type table) for effective motor protection.
- Electrical connection**
 Standard terminal box (IP55) on back of motor. Additionally on outside of duct for HRF types. Different for explosion-proof types.
- Protection grille**
 Made of powder-coated steel wire for HQ (Ex types galvanised). In accordance with DIN EN ISO 13857.

- Power control**
 The voltage-controllable types are identified in the "Current consumption max. with control" column with a value which must be observed when determining the controller (see speed controller column). Possible assignments of frequency inverters to fans are shown in the type table. The planned use of a frequency inverter without a sine filter should be indicated when placing the order. This requires a change of fan version and additional costs, if necessary. The flow rates are shown in the performance diagram.
- Reverse operation**
 All types are reversible using a reverser switch. Performance reduction of approx. 1/3 in abnormal flow direction.

- Installation**
 Installation possible in any position, but be aware of any condensate drain holes depending on usage.
- Dimensions**
 Pole-changeable and explosion-proof types may differ from the above information.
- Noise levels**
 See performance diagram. The sound power and sound pressure at 4 m distance under free field conditions are specified for the average operating point on the inlet/outlet side. See page 14 f for noise emissions and room acoustics. Different for explosion-proof types.

Speed min ⁻¹	Flow rate free-blowing V m ³ /h	Power consump. W	Current consump.		Wiring dia- gram No.	Max. air flow temp.		Weight net aprx. kg	Design type		Frequency inverter with integrated sine filter Type	Transformer speed con- troller 5-step, pole chan- ging switch, speed ch., pole changing switch Type				
			at rated voltage A	max. with control A		at rated voltage + °C	with control + °C		HQ incl. prot. grille Ref. no.	HRF Ref. no.			Ref. no.	Ref. no.		
Single-phase alternating current, 230 Volt, 50 Hz, Capacitor motor, protection category IP55																
935	8130	0.27	1.40	2.00	475 ¹⁾	60	40	24.0	HQW 560/6	00385	HRFW 560/6¹⁾	00380	—	MWS 3²⁾	01948	
1370	12180	0.89	4.15	5.00	965	60	40	31.0	HQW 560/4	05054	HRFW 560/4	05055	—	MWS 7.5²⁾	01950	
Three-phase current, 400 Volt, 50 Hz, Squirrel-cage rotor, protection category IP55																
965	8180	0.28	0.79	1.00	469	60	40	26.0	HQD 560/6	00386	HRFD 560/6	00381	FU-BS 2.5²⁾	05459	RDS 2²⁾	01315
1365	12250	0.88	1.71	1.80	469	40	40	29.0	HQD 560/4	00387	HRFD 560/4	00382	FU-BS 2.5²⁾	05459	RDS 2²⁾	01315
Pole-changeable, 2 speeds, three-phase current, Dahlander winding, 400 Volt, 50 Hz, protection category IP55																
470/955	4000/8130	0.089/0.298	0.55/0.74	—	472	60	—	24.0	HQD 560/12/6	00389	HRFD 560/12/6	00384	—	PDA 12²⁾	05081	
720/1365	6400/12130	0.20/0.92	0.80/1.77	—	472	40	—	26.0	HQD 560/8/4	00388	HRFD 560/8/4	00383	—	PDA 12²⁾	05081	
Explosion-proof, II 2G Ex h IIB + H₂ T3 Gb, Motor Ex e, three-phase current 400 Volt, 50 Hz, protection category IP55																
920	8090	0.25*	0.97*	—	470	40	—	23.0	HQD 560/6 Ex	00378	HRFD 560/6 Ex	00376	—	Not permitted		
1390	12890	0.75*	2.00*	—	470	40	—	24.0	HQD 560/4 Ex	00379	HRFD 560/4 Ex	00377	—	Not permitted		

* For Ex types: Motor ratings see information on page 20. ¹⁾ Type HRFW: Connection according to wiring diagram no. 965. ²⁾ Incl. motor protection circuit breaker. ³⁾ Flush-m. version see Switch product page.

Performance curves 560/4

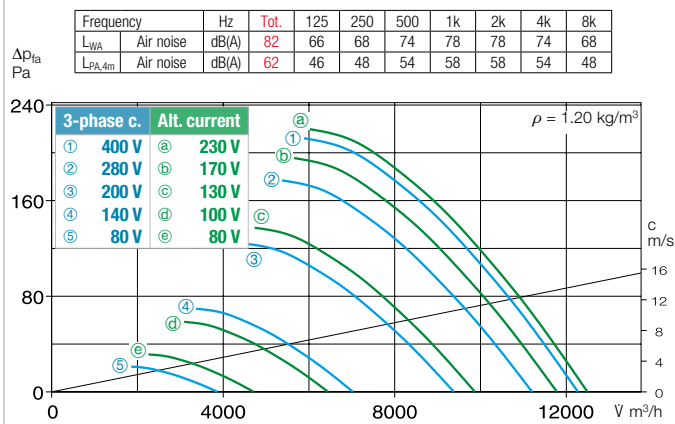

Performance curves 560/6

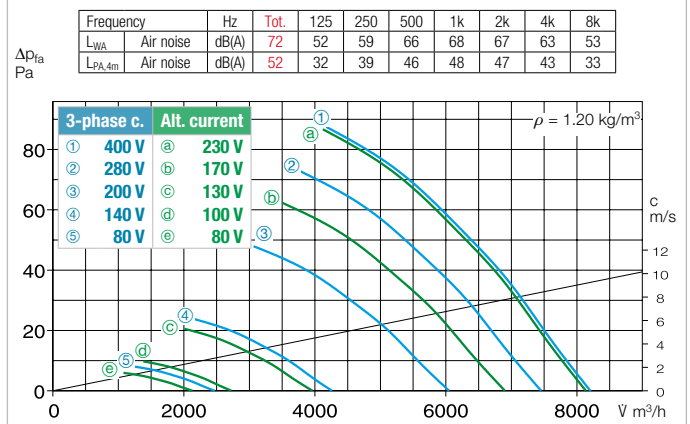

Performance curve 560/8

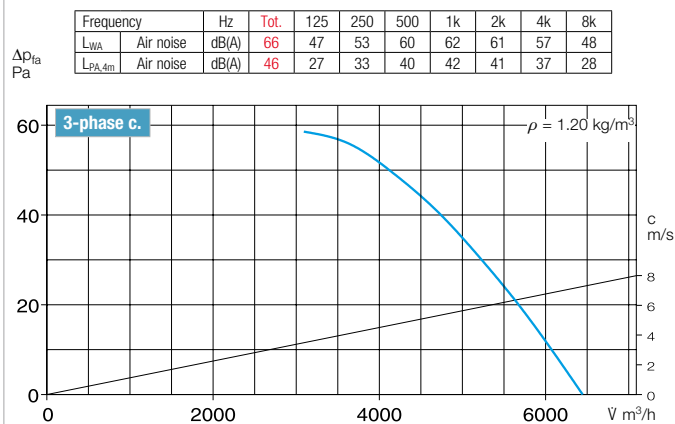

Performance curve 560/12

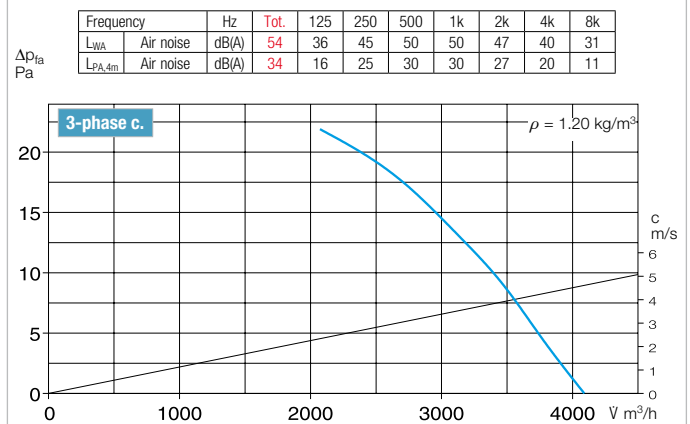

Accessories for HRF 560 Description see page 276 ff.

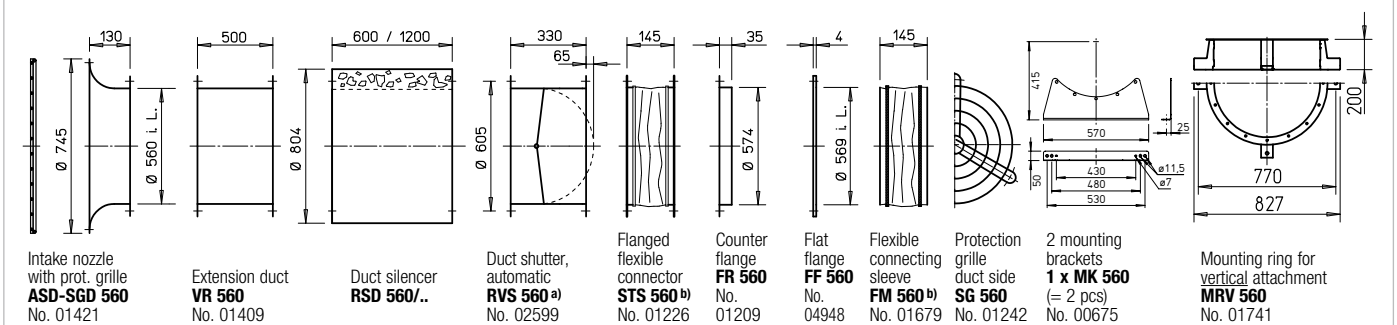

a) Shutter, motorised see Accessories product pages.

b) See below for types for explosion-proof fans.

Type	Ref. no.	Type	Ref. no.	Type	Ref. no.
Electronic speed controller, continuously variable flush-m./surface-m.		Motor protection circuit breaker for connecting built-in thermal contacts		Reverser switch	
ESU 3/ESA 3	00237/00239	MW	01579	WS	01271
ESU 5/ESA 5	01296/01299	MW	01579	WS	01271
ESD 5 a)	00501	MD	05849	WS	01271
ESD 5 a)	00501	MD	05849	WS	01271
—	—	M 3 a)	01293	PWDA	01282
—	—	M 3 a)	01293	PWDA	01282
not permitted	—	—	—	—	—
not permitted	—	—	—	—	—

a) Incl. speed pole changing switch.

Reference	Page
Techn. description	180
Selection table	181
Planning information	14 ff.
Special design	
Different voltage, protection category, air flow direction, higher air flow temperature, acid protection and impeller made of cast aluminium upon request.	
The technical information on p. 19 ff. must be observed.	

Other accessories	Page
b) Access. for expl.-proof fans	
Flanged flexible connector STS 560 Ex	Ref. no. 02508
Silencers	494 ff.
Shutters and ventilation grilles	561 ff.
Speed controllers, controllers and switches	599 ff.
Flexible connecting sleeve FM 560 Ex	Ref. no. 01695

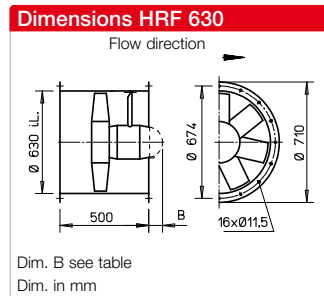
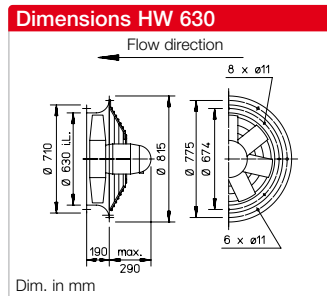
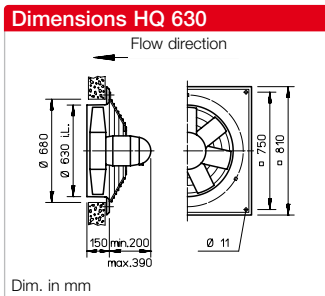

Description for all types

- **Casing**
 Made of galvanised steel sheet.
- **Impeller**
 High performance characteristics with profiled blades made of plastic, dynamically balanced. Different for explosion-proof types.
- **Drive**
 Closed die-cast aluminium casing. Protection category IP55. Ball bearing mounted. Maintenance-free and radio interference-free. Winding with moisture proof coating. See type table for max. air flow temperature. Different for explosion-proof types.
- **Motor protection**
 All types (except for ..8/4 and explosion-proof types, see page 180) are equipped with thermal contacts. These should be wired with the motor protection circuit breaker (see type table) for

- effective motor protection. Motors without thermal contacts must be protected by means of on-site a motor protection circuit breaker.
- **Electrical connection**
 Standard terminal box (IP55) on back of motor. Additionally on outside of duct for HRF types. Different for explosion-proof types.
- **Protection grille**
 Made of powder-coated steel for HQ and HW (HQ.. Ex galvanised). In accordance with DIN EN ISO 13857.
- **Power control**
 The voltage-controllable types are identified in the "Current consumption max. with control" column with a value which must be observed when determining the controller (see speed controller column). Possible assignments of frequency inverters to fans are shown in the type

- table. The planned use of a frequency inverter without a sine filter should be indicated when placing the order. This requires a change of fan version and additional costs, if necessary. The flow rates are shown in the performance diagram.
- **Reverse operation**
 All types are reversible using a reverser switch. Performance reduction of approx. 1/3 in abnormal flow direction.
- **Installation**
 Installation possible in any position, but be aware of any condensate drain holes depending on usage.
- **Dimensions**
 Pole-changeable and explosion-proof types may differ from the above information.

- **Noise levels**
 See performance diagram. The sound power and sound pressure at 4 m distance under free field conditions are specified for the average operating point on the inlet/outlet side. See page 14 f for noise emissions and room acoustics. Different for explosion-proof types.
- | Reference | Page |
|----------------------|--------|
| Techn. description | 180 |
| Selection table | 181 |
| Planning information | 14 ff. |
- Special design**
 Different voltage, protection category, air flow direction, higher air flow temperature, acid protection and impeller in other materials upon request.
- The technical information on p. 19 ff. must be observed.

Speed	Flow rate free-blowing	Power consump.	Current consump.		Wiring diagram	Max. air flow temp.		Weight net appr.	Design type						
			at rated voltage	max. with control		at rated voltage	with control		HQ incl. protection grille	Ref. no.	HW incl. protection grille	Ref. no.	HRF	Ref. no.	Dim. B Motor protrusion in mm
min ⁻¹	V m ³ /h	W	A	A	No.	+ °C	+ °C	kg							
Single-phase alternating current, 230 Volt, 50 Hz, Capacitor motor, protection category IP55															
950	10530	0.44	2.16	3.20	475	60	40	28.0	HQW 630/6	05037	—	—	—	—	—
1325	16210	1.50*	8.40*	7.00	964	40	—	40.0	HQW 630/4	05056	—	—	HRFW 630/4	05057	30
Three-phase current, 400 Volt, 50 Hz, Squirrel-cage rotor, protection category IP55															
710	7810	0.20	0.66	0.70	469	40	40	27.0	HQD 630/8	05029	—	—	—	—	—
960	10560	0.44	1.22	—	469	60	40	30.5	HQD 630/6	05027	HWD 630/6	01032	HRFD 630/6	00244	—
Two-speed, three-phase current, 400 V, 50 Hz, ∇/Δ connection, protection category IP55															
1170/1390	14310/17000	0.90/1.57	2.3/3.8	—	520	40	—	37.5	HQD 630/4/4	05030	HWD 630/4/4	01033	HRFD 630/4/4	00245	—
Pole-changeable, 2 speeds, three-phase current, Dahlander winding, 400 Volt, 50 Hz, protection category IP55															
440/935	5290/10470	0.14/0.43	0.60/1.13	—	472	60	—	41.0	HQD 630/12/6	05031	—	—	HRFD 630/12/6	00410	—
690/1400	7990/15990	0.37/1.50*	1.33/3.70*	—	471	40	—	40.5	HQD 630/8/4	05032	—	—	HRFD 630/8/4	00411	—
 Ex Explosion-proof, II 2G Ex h IIB + H₂ T3 Gb, Motor Ex e, three-phase current 400 Volt, 50 Hz, protection category IP55															
910	10480	0.55*	1.75*	—	470	40	—	30.0	HQD 630/6 Ex	05035	—	—	HRFD 630/6 Ex	00494	—
1410	17730	1.35*	3.10*	—	470	40	—	35.0	HQD 630/4 Ex	05036	—	—	HRFD 630/4 Ex	00495	—

* For Ex types: Motor ratings see information on page 20. ¹⁾ Incl. motor protection circuit breaker. ²⁾ Flush-m. version see Switch product page.

Performance curves 630/4

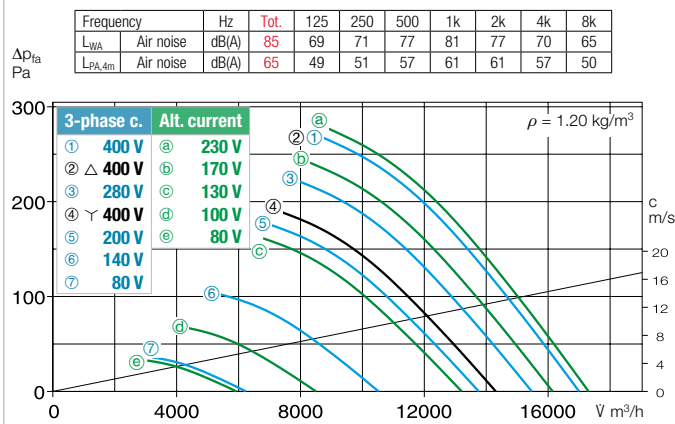

Performance curves 630/6

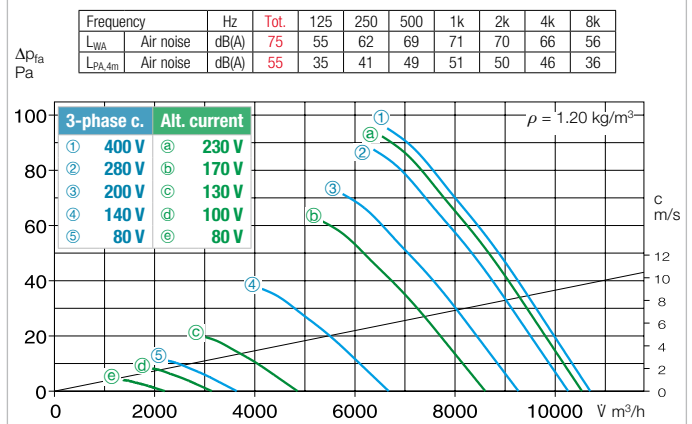

Performance curves 630/8

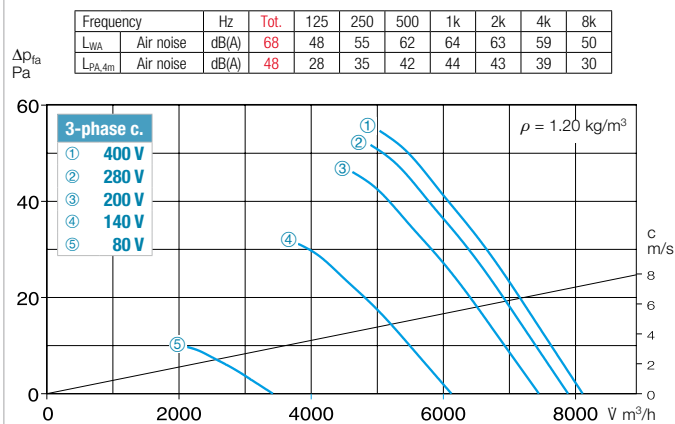

Performance curve 630/12

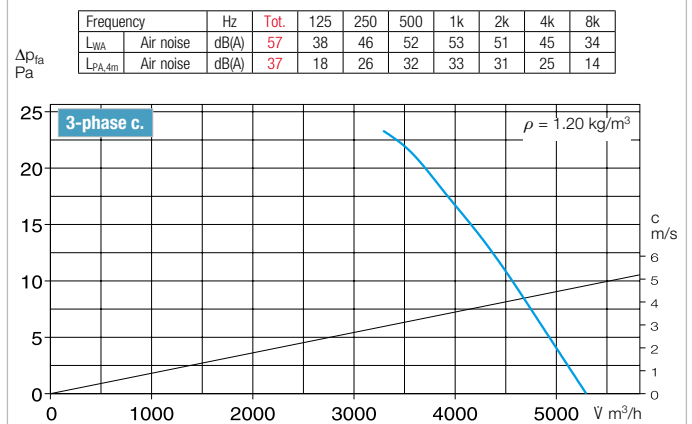

Accessories for HRF 630 Description see page 276 ff.

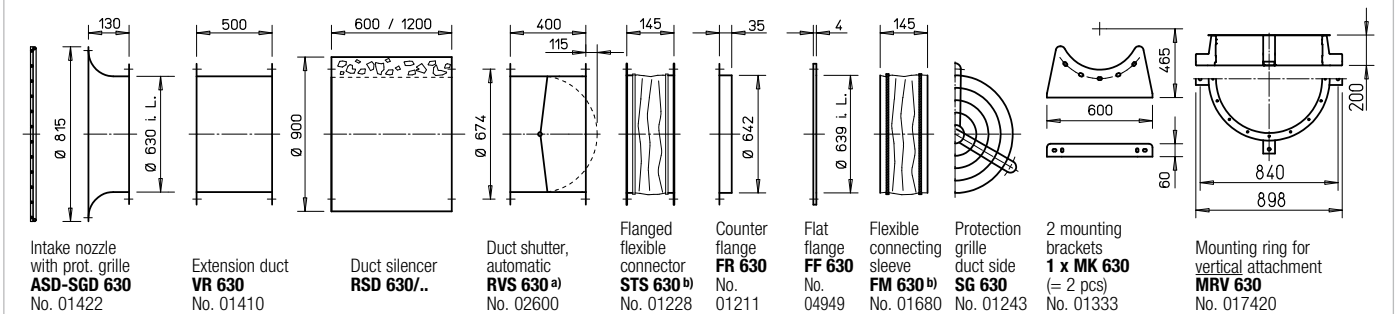

a) Shutter, motorised see Accessories product pages.

b) See below for types for explosion-proof fans.

Frequency inverter with integrated sine filter		Transformer speed controller 5-step, pole changing switch		Electronic speed controller, continuously variable flush-m./surface-m.		Motor protection circuit breaker for connecting built-in thermal contacts		Reverser switch	
Type	Ref. no.	Type	Ref. no.	Type	Ref. no.	Type	Ref. no.	Type	Ref. no.
—	—	MWS 3 ¹⁾	01948	ESU 5/ESA 5	01296/01299	MW	01579	WS	01271
—	—	MWS 7.5 ¹⁾	01950	—	—	MW	01579	WS	01271
FU-BS 2.5 ¹⁾	05459	RDS 2 ¹⁾	01315	ESD 5 ¹⁾	00501	MD	05849	WS	01271
FU-BS 2.5 ¹⁾	05459	RDS 2 ¹⁾	01315	ESD 5 ¹⁾	00501	MD	05849	WS	01271
FU-BS 5.0 ¹⁾	05460	RDS 4 ¹⁾	01316	ESD 5 ¹⁾	00501	M 4 ³⁾	01571	WS	01271
—	—	Pole changing switch		—	—	M 3 ³⁾	01293	PWDA	01282
—	—	PDA 12 ²⁾	05081	—	—	M 3 ³⁾	01293	PWDA	01282
—	—	—	—	—	—	—	—	—	—
—	—	not permitted	—	not permitted	—	—	—	—	—
—	—	not permitted	—	not permitted	—	—	—	—	—

³⁾ Incl. speed pole changing switch.

Other accessories Page

^{b)} Access. for expl.-proof fans	
Flanged flexible connector STS 630 Ex	Ref. no. 02509
Silencers	494 ff.
Shutters and ventilation grilles	561 ff.
Speed controllers, controllers and switches	599 ff.
Flexible connecting sleeve FM 630 Ex	Ref. no. 01696

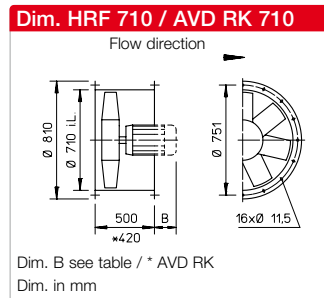
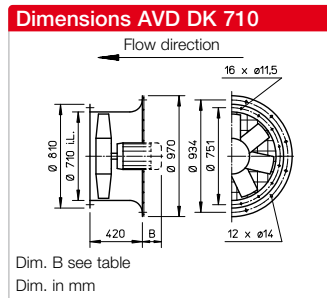
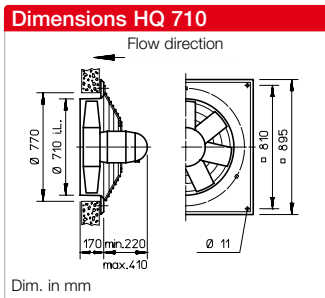

Description for all types

- Casing**
With motor mount made of galvanised steel sheet.
- Impeller**
High performance characteristics with profiled blades made of plastic, dynamically balanced. Different for explosion-proof types.
- Angle of attack**
The impeller blades can be adjusted for optimal operating point coverage (except for explosion-proof types and type HQW 710/6). The angle of attack is adjusted (according to the order) and fixed at the factory.

- The motor is assigned using the maximum power according to the information in the table below. The specified angle of attack must not be exceeded.
- Drive**
Closed design type IP55 or IP54. Maintenance-free and radio interference-free. Tropicalised winding with moisture proof coating. Different for explosion-proof types.
- Motor protection**
All types (except for pole-changeable and explosion-proof types, see page 180) are equipped with thermal contacts or PTC thermistors and must be protected by means of the following

- motor protection devices according to the footnotes the table:
¹MW/MD, Ref. no. 01579/05849
²MSA, Ref. no. 01289 (for PTC thermistor temperature sensor)
³M 4, Ref. no. 01571
 All other types must be protected by means of on-site a motor protection circuit breaker.
- Protection grille**
Hot-dip galvanised or powder-coated for HQ and AVD DK as standard in accordance with DIN EN ISO 13857.
- Electrical connection**
Terminal box in protection category IP54 mounted on motor. Additionally on outside of duct

for HRF types. Different for explosion-proof types.

- Power control**
Partly through voltage reduction, see "Transformer speed controller" column. Regulated performance curve upon request.
Frequency inverter possible for all types (except for pole-changeable and explosion-proof types). The planned use of a frequency inverter without a sine filter should be indicated when placing the order. This requires a change of fan version and additional costs, if necessary.
- Reverse operation**
All types are reversible using a reverser switch. Performance reduction of approx. 1/3 in abnormal flow direction.

- Installation**
Installation possible in any position, but be aware of any condensate drain holes depending on usage.

- Dimensions**
Pole-changeable and explosion-proof types may differ from the above information. Motor lengths may vary. Take note of dim. B protrusion.

- Noise levels**
The sound power values over the frequency and as total levels are indicated above the performance diagrams. Different for explosion-proof types.

Speed min ⁻¹	Flow rate free blowing V m ³ /h	Rated motor power (output)* kW	Voltage V	Current consump. Rat. volt./ (control)* A	Max. position ° deg.	Wiring dia- gram No.	Max. air flow temp. + °C	Wgt net appr.** kg	Design type				Transformer speed controller 5-step, pole changing switch					
									HQ incl. protection grille	Ref. no.	AVD DK incl. protection grille	Ref. no. Dim. B Motor protr. in mm	HRFD AVD RK	Ref. no. Dim. B Motor protr. in mm	Type	Ref. no.		
Single-phase alternating current. 230 Volt, 50 Hz, Capacitor motor, protection category IP55																		
910	14200	0.60	230	2.6	25	965	40	40.0	HQW 710/6 ¹⁾	05047	—	—	—	MWS 5 ⁴⁾	01949			
Three-phase current, 400 Volt, 50 Hz, Squirrel-cage rotor, protection category IP45																		
690	13330	0.29	400	0.9	20	469	40	57.0	HQD 710/8 ¹⁾	05599	AVD DK 710/8 ¹⁾	05251	—	HRFD 710/8 ¹⁾	06930	RDS 2 ⁴⁾	01315	
940	15660/19170	1.1*	230/400	5.1*	35	776	40	60.0	HQD 710/6 ¹⁾	05603	AVD DK 710/6 ¹⁾	05255	145	HRFD 710/6 ¹⁾	06934	10	TSB 7	01504
1445	26420	3.00*	400/690	6.2*	30	776	40	88.0	HQD 710/4 ²⁾	05606	AVD DK 710/4 ²⁾	05258	175	HRFD 710/4 ²⁾	06937	35	TSB 11	01513
Two-speed, three-phase current, 400 V, 50 Hz, protection category IP55																		
730/890	13550/16090	0.4/0.75*	400/400	1.1/2.3*	25	520	40	55.0	HQD 710/6/6 ³⁾	05602	AVD DK 710/6/6 ³⁾	05254	120	HRFD 710/6/6 ³⁾	06933	5	RDS 4 ⁴⁾	01316
1120/1360	16140/19670	0.95/1.55*	400/400	2.4/4.2*	20	520	40	60.0	HQD 710/4/4 ³⁾	05604	AVD DK 710/4/4 ³⁾	05256	145	HRFD 710/4/4 ³⁾	06935	—	RDS 7 ⁴⁾	01578
1030/1340	19370/23280	1.5/2.2*	400/400	3.0/5.2*	26	520	40	75.0	HQD 710/4/4 ³⁾	05605	AVD DK 710/4/4 ³⁾	05257	170	HRFD 710/4/4 ³⁾	06936	35	RDS 7 ⁴⁾	01578
Pole-changeable, 2 speeds, three-phase current, Dahlander winding, 400 Volt, 50 Hz, protection category IP45																		
685/1430	10810/22090	0.5/2.0*	400/400	2.0/4.7	23	471	40	82.0	HQD 710/8/4/..	05611	AVD DK 710/8/4/..	05263	160	HRFD 710/8/4/..	06942	20	PDA 12 ⁵⁾	05081
720/1440	14155/26200	0.9/3.6*	400/400	2.9/8.3	30	471	40	108.0	HQD 710/8/4/..	05612	AVD DK 710/8/4/..	05264	175	AVD RK 710/8/4/..	06943	90	PDA 12 ⁵⁾	05081
Explosion-proof, II 2G Ex h IIB + H₂ T3 Gb, Motor Ex e, three-phase current 400 Volt, 50 Hz, protection category IP55																		
700	13270	0.55*	400	2.2*	35	470	40	68.0	HQD 710/8 Ex	05618	AVD DK 710/8 Ex	05270	105	HRFD 710/8 Ex	06948	—	not permitted	
930	13480	0.55*	400	1.8*	25	470	40	67.0	HQD 710/6 Ex	05620	AVD DK 710/6 Ex	05272	105	HRFD 710/6 Ex	06949	—	not permitted	
930	16770	0.95*	400	2.7*	35	470	40	77.0	HQD 710/6 Ex	05621	AVD DK 710/6 Ex	05273	105	HRFD 710/6 Ex	06950	—	not permitted	
1420	20540	2.00*	400	4.7*	25	470	40	82.0	HQD 710/4 Ex	05623	AVD DK 710/4 Ex	05275	130	AVD RK 710/4 Ex	06951	45	not permitted	
1420	26160	3.60*	400/690	8.1*	35	498	40	102.0	HQD 710/4 Ex	05624	AVD DK 710/4 Ex	05276	190	AVD RK 710/4 Ex	06952	105	not permitted	

* Motor ratings, Ex see information p. 20. ¹⁾ up to ³⁾ Motor protection devices, see description "Motor protection". ** Weights apply for type ..DK and ..RK, HRF and HQ minus approx. 15 kg. ⁴⁾ Incl. motor protection circuit breaker 1.2/2.2 kW.

Performance curves 710/4

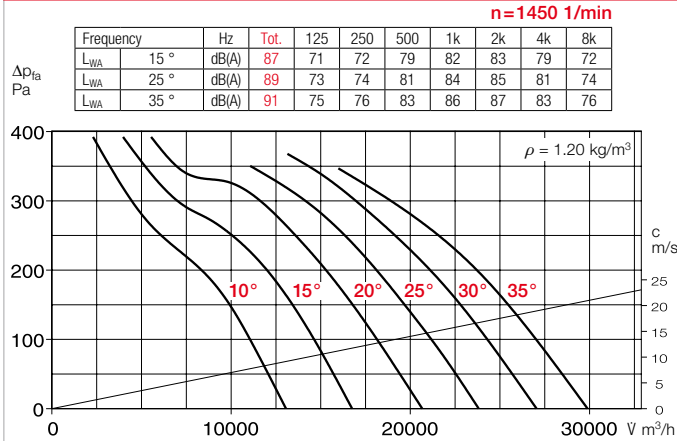

Performance curves 710/6 – Alternating current

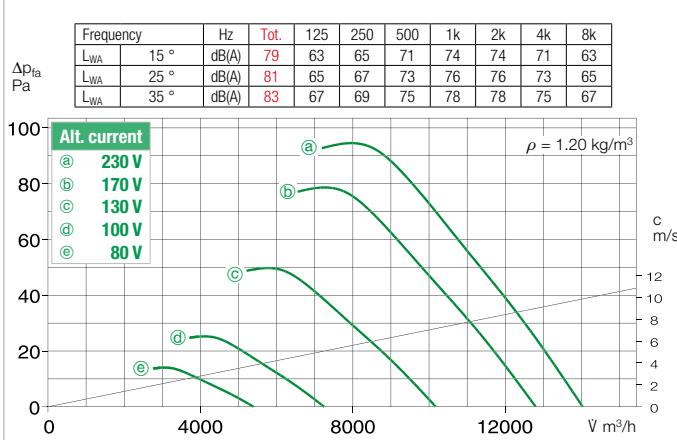

Performance curves 710/6 – Three-phase current

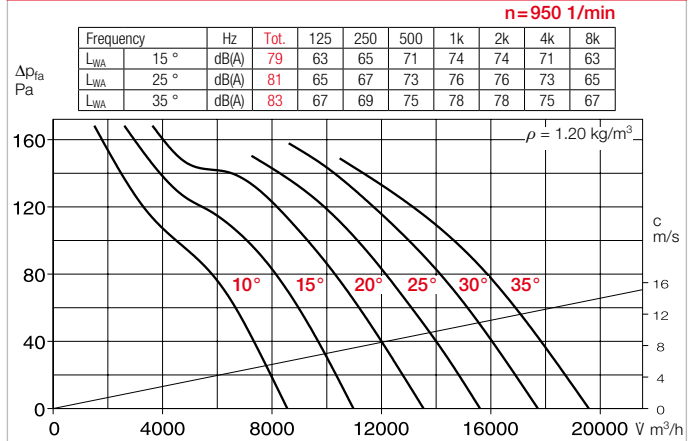

Performance curves 710/8

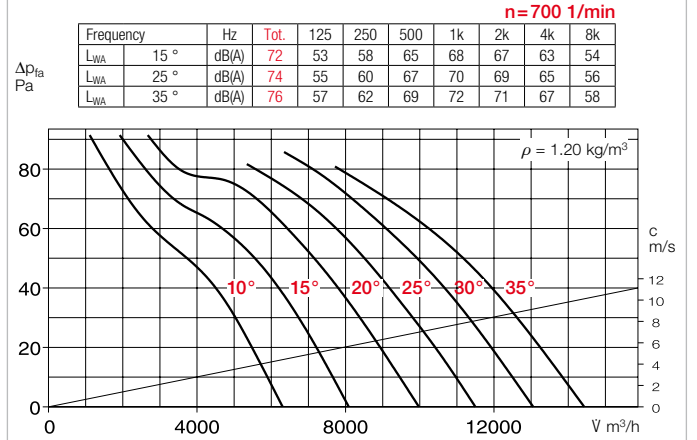

Axial and VAR fans

Accessories for HRF 710 / AVD RK 710 Description see page 276 ff.

Elec. speed controller, continuously variable Frequency inverter with sine filter		Vibration damper Nominal size	
Type	Ref. no.	Type	Ref. no.
—	—	..1/.1	01452/01454
EDS 5 ⁴⁾	00501	..1/.1	01452/01454
FU-BS 8.0 ⁴⁾	05461	..1/.1	01452/01454
FU-BS 8.0 ⁴⁾	05461	..2/.2	01453/01455
EDS 5 ⁴⁾	00501	..1/.1	01452/01454
EDS 5 ⁴⁾	00501	..1/.1	01452/01454
EDS 11.5 ⁴⁾	00502	..2/.2	01453/01455
—	—	..2/.2	01453/01455
—	—	..2/.2	01453/01455
not permitted	..1/.2	01452/01455	
not permitted	..1/.2	01452/01455	
not permitted	..1/.2	01452/01455	
not permitted	..2/.2	01453/01455	
not permitted	..2/.2	01453/01455	

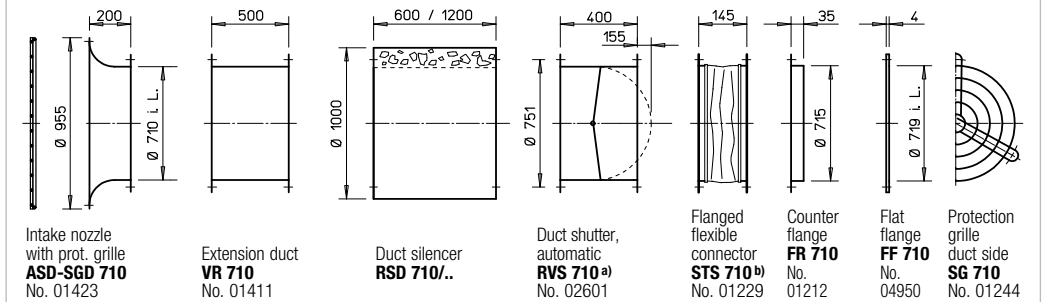

^{a)} Shutter, motorised see Accessories product pages.

^{b)} See below for types for explosion-proof fans.

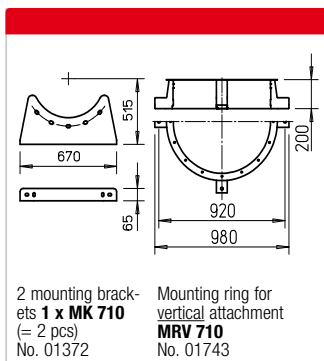

Reference	Page
Techn. description	180
Selection table	181
Planning information	14 ff.

Special design

Different voltage, protection category, air flow temperature, acid protection and impeller made of cast aluminium upon request.

Other accessories	Page
^{b)} Access. for expl.-proof fans	
Flanged flexible connector STS 710 Ex	Ref. no. 02510
Silencers	494 ff.
Shutters and ventilation grilles	561 ff.
Speed controllers, controllers and switches	599 ff.

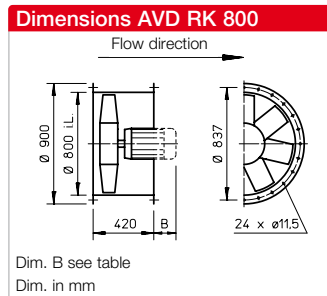
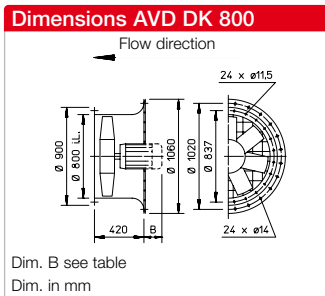

Description for all types

- **Casing**
 With motor mount made of galvanized steel sheet.
- **Impeller**
 High performance characteristics with profiled blades made of plastic, dynamically balanced. Different for explosion-proof types.
- **Angle of attack**
 The impeller blades can be adjusted for optimal operating point coverage (except for explosion-proof types). The angle of attack is adjusted (according to the order) and fixed at the factory. The motor is assigned using the maximum power according to the information in the table below. The specified angle of attack must not be exceeded.

- **Drive**
 Closed design type IP55 or IP54. Maintenance-free and radio interference-free. Tropicalised winding with moisture proof coating. Different for explosion-proof types.
- **Motor protection**
 All types (except for pole-changeable and explosion-proof types, see page 180) are equipped with thermal contacts or PTC thermistors and must be protected by means of the following motor protection devices according to the footnotes the table:
⁴⁾MSA, Ref. no. 01289 (for PTC thermistor temperature sensor)
⁵⁾M 4, Ref. no. 01571
 All other types must be protected by means of on-site a motor protection circuit breaker.

- **Electrical connection**
 Terminal box in protection category IP54 mounted on motor.
- **Protection grille**
 Hot-dip galvanised for AVD DK as standard in accordance with DIN EN ISO 13857.
- **Power control**
 Partly through voltage reduction, see "Transformer speed controller" column. Regulated performance performance curve upon request. Frequency inverter possible for all types (except for pole-changeable and explosion-proof types). The planned use of a frequency inverter without a sine filter should be indicated when placing the order. This requires a change of fan version and additional costs, if necessary.

- **Reverse operation**
 All types are reversible using a reverser switch. Performance reduction of approx. 1/3 in abnormal flow direction.
- **Installation**
 Installation possible in any position, but be aware of any condensate drain holes depending on usage.
- **Dimensions**
 Pole-changeable and explosion-proof types may differ from the above information. Motor lengths may vary. Take note of dim. B protrusion.
- **Noise levels**
 The sound power values over the frequency and as total levels are indicated above the performance diagrams. Different for explosion-proof types.

Speed min ⁻¹	Flow rate free blowing V m ³ /h	Rated motor power (output)* kW	Voltage V	Current consump. Rat. volt./ (control)* A	Max. position ° deg.	Wiring dia- gram No.	Max. air flow temp. + °C	Wgt net aprx.** kg	Design type						Transformer speed controller 5-step, pole changing switch	
									AVD DK incl. protection grille	Ref. no.	Dim. B Motor protr. in mm	AVD RK	Ref. no.	Dim. B Motor protr. in mm	Type	Ref. no.
Three-phase current, 50 Hz, Squirrel-cage rotor, protection category IP54																
1445	33450	4.00*	400/690	8.3*	26	776	40	101	AVD DK 800/4/.. ⁴⁾	05311	210	AVD RK 800/4/.. ⁴⁾	06960	210	—	—
1450	39130	5.5*	400/690	11*	33	776	40	115	AVD DK 800/4/.. ⁴⁾	05312	290	AVD RK 800/4/.. ⁴⁾	06961	290	—	—
Two-speed, three-phase current, 400 V, 50 Hz, protection category IP55																
775/920	15720/18670	0.40/0.75*	400/400	1.1/2.3*	22	520	40	70	AVD DK 800/6/6.. ⁵⁾	05307	125	AVD RK 800/6/6.. ⁵⁾	06956	125	RDS 4 ²⁾	01316
Pole-changeable, 2 speeds, three-phase current, 50 Hz, protection category IP54																
695/1400	10020/20180	0.37/1.50*	400/400	1.3/3.7*	12	471	40	95	AVD DK 800/8/4.. ¹⁾	05319	135	AVD RK 800/8/4/.. ¹⁾	06968	135	PDA 12 ³⁾	05081
Explosion-proof, II 2G Ex h IIB + H₂ T3 Gb, Motor Ex e, three-phase current 400 Volt, 50 Hz, protection category IP55																
700	17190	0.55*	400	2.2*	32	470	40	81	AVD DK 800/8 Ex/..	05326	135	AVD RK 800/8 Ex/..	06974	135	not permitted	—
930	20340	0.95*	400	2.7*	23	470	40	90	AVD DK 800/6 Ex/..	05329	135	AVD RK 800/6 Ex/..	06976	135	not permitted	—
950	26710	1.9*	400	4.7*	35	470	40	118	AVD DK 800/6 Ex/..	05330	210	AVD RK 800/6 Ex/..	06977	210	not permitted	—
1420	31900	3.60*	400/690	8.1*	24	498	40	115	AVD DK 800/4 Ex/..	05332	210	AVD RK 800/4 Ex/..	06978	210	not permitted	—
1450	36820	5.00*	400/690	10.1*	30	498	40	143	AVD DK 800/4 Ex/..	05333	290	AVD RK 800/4 Ex/..	06979	290	not permitted	—

* Motor ratings, Ex see information p. 20. ¹⁾ Dahlander winding. ²⁾ Incl motor protection circuit breaker. ³⁾ Flush-m. version see Switch product page.
⁴⁾ and ⁵⁾ Motor protection devices, see description "Motor protection".

Performance curves 800/4

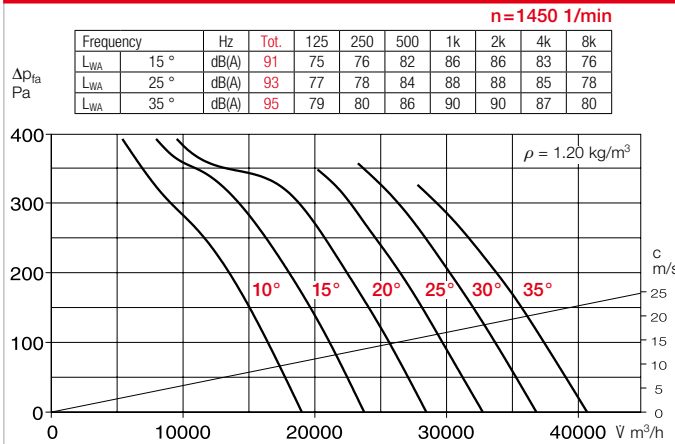

Performance curves 800/6

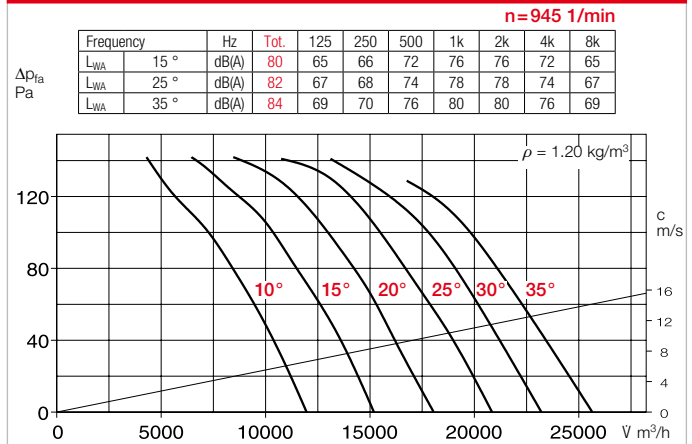

Performance curves 800/8

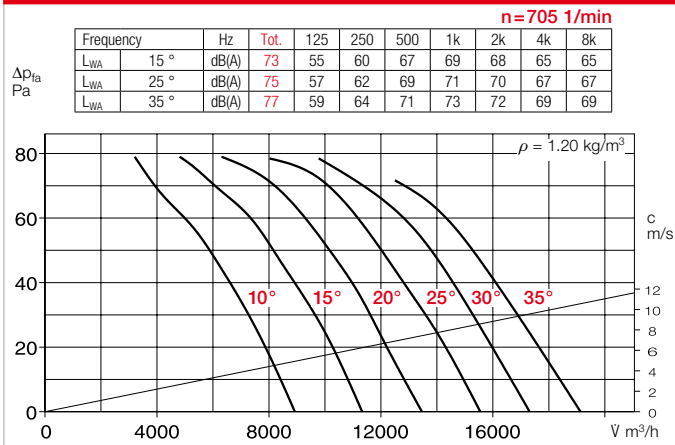

Accessories for AVD RK 800 Description see page 276 ff.

<p>Intake nozzle with prot. grille ASD-SGD 800 No. 01424</p>	<p>Extension duct VR 800 No. 01412</p>	<p>Duct silencer RSD 800/..</p>	<p>Duct shutter, automatic RVS 800 a) No. 02602</p>	<p>Flanged flexible connector STS 800 b) No. 01233</p>	<p>Counter flange FR 800 No. 01198</p>	<p>Flat flange FF 800 No. 04951</p>	<p>Protection grille duct side SG 800 No. 01245</p>	<p>2 mounting brackets 1 x MK 800 (= 2 pcs) No. 01373</p>	<p>Mounting ring for vertical attachment MRV 800 No. 01744</p>
---	---	--	--	---	---	--	--	--	---

a) Shutter, motorised see Accessories product pages.

b) See below for types for explosion-proof fans.

Elec. speed controller, continuously variable Frequency inverter with sine filter		Vibration damper Nominal size SDD/SDZ	
Type	Ref. no.	Type	Ref. no.
FU-BS 10 ^{a)}	05462	..2/..2	01453/01455
FU-BS 14 ^{a)}	05463	—	—
EDS 5 ^{a)}	00501	..2/..2	01453/01455
—	—	..2/..2	01453/01455
not permitted	—	..2/..2	01453/01455
not permitted	—	..2/..2	01453/01455
not permitted	—	..2/..2	01453/01455
not permitted	—	..2/..2	01453/01455
not permitted	—	..2/..2	01453/01455

Reference	Page
Techn. description	180
Selection table	181
Planning information	14 ff.
Special design	
Different voltage, protection category, air flow direction, higher air flow temperature, acid protection and impeller made of cast aluminium upon request.	
The technical information on p. 19 ff. must be observed.	

Other accessories	Page
^{b)} Access. for expl.-proof fans	
Flanged flexible connector STS 800 Ex	Ref. no. 02511
Silencers	494 ff.
Shutters and ventilation grilles	561 ff.
Speed controllers, controllers and switches	599 ff.

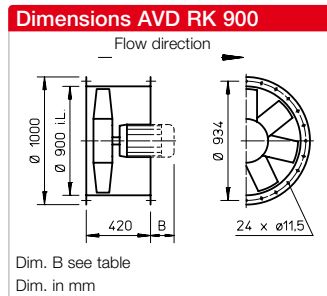
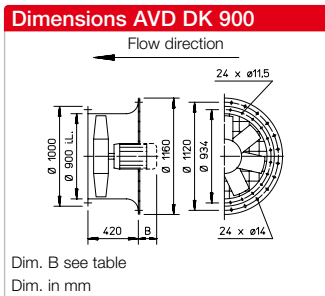

Description for all types

- **Casing**
 With motor mount made of galvanized steel sheet.
- **Impeller**
 High performance characteristics with profiled blades made of plastic, dynamically balanced. Different for explosion-proof types.
- **Angle of attack**
 The impeller blades can be adjusted for optimal operating point coverage (except for explosion-proof types). The angle of attack is adjusted (according to the order) and fixed at the factory. The motor is assigned according to the information in the table below. The specified angle of attack must not be exceeded.

- **Drive**
 Closed design type IP55 or IP54. Maintenance-free and radio interference-free. Tropicalised winding with moisture proof coating. Different for explosion-proof types.
- **Motor protection**
 All types (Ref. no. 05380 Ref. no. 06996 and explosion-proof, see page 180) are equipped with thermal contacts or PTC thermistors and must be protected by means of the following motor protection devices according to the footnotes the table:
⁴⁾MSA, Ref. no. 01289 (for PTC thermistor temperature sensor)
⁵⁾M 4, Ref. no. 01571
 All other types must be protected by means of on-site a motor protection circuit breaker.

- **Electrical connection**
 Terminal box in protection category IP54 mounted on motor.
- **Protection grille**
 Hot-dip galvanised for AVD DK as standard in accordance with DIN EN ISO 13857.
- **Power control**
 Partly through voltage reduction, see "Transformer speed controller" column. Regulated performance performance curve upon request. Frequency inverter possible for all types (except for pole-changeable and explosion-proof types). The planned use of a frequency inverter without a sine filter should be indicated when placing the order. This requires a change of fan version and additional costs, if necessary.

- **Reverse operation**
 All types are reversible using a reverser switch. Performance reduction of approx. 1/3 in abnormal flow direction.
- **Installation**
 Installation possible in any position, but be aware of any condensate drain holes depending on usage.
- **Dimensions**
 Pole-changeable and explosion-proof types may differ from the above information. Motor lengths may vary. Take note of dim. B protrusion.
- **Noise levels**
 The sound power values over the frequency and as total levels are indicated above the performance diagrams. Different for explosion-proof types.

Speed	Flow rate free blowing	Rated motor power (output)*	Voltage	Current consump. Rat. volt./ (control)*	Max. position	Wiring dia-gram	Max. air flow temp.	Wgt net appr.**	Design type							
									AVD DK incl. protection grille	Ref. no.	Dim. B Motor protr. in mm	AVD RK	Ref. no.	Dim. B Motor protr. in mm	Transformer speed controller 5-step, pole changing switch	
min ⁻¹	V m ³ /h	kW	V	A	° deg.	No.	+ °C	kg	Type	Ref. no.						
Three-phase current, 50 Hz, Squirrel-cage rotor, protection category IP54																
950	37300	3.00*	400/690	6.2*	34	776	40	130	AVD DK 900/6/.. ⁴⁾	05369	290	AVD RK 900/6/.. ⁴⁾	06985	290	—	
1445	35030	4.00*	400/690	8.3*	16	776	40	118	AVD DK 900/4/.. ⁴⁾	05370	210	AVD RK 900/4/.. ⁴⁾	06986	210	—	
1450	48995	7.50*	400/690	14.5*	27	776	40	142	AVD DK 900/4/.. ⁴⁾	05371	325	AVD RK 900/4/.. ⁴⁾	06987	325	—	
1470	57720	11.00*	400/690	20.0*	34	776	40	186	AVD DK 900/4/.. ⁴⁾	05372	385	AVD RK 900/4/.. ⁴⁾	06988	385	—	
Two-speed, three-phase current, 400 V, 50 Hz, √3 connection, protection category IP55																
775/930	18390/22660	0.71/1.32*	400/400	2.1/4.0*	19	520	40	90	AVD DK 900/6/6.. ⁵⁾	05367	180	AVD RK 900/6/6.. ⁵⁾	06983	180	RDS 7 ²⁾	01578
770/920	25990/31060	1.38/2.37*	400/400	3.9/7.1*	27	520	40	115	AVD DK 900/6/6.. ⁵⁾	05368	210	AVD RK 900/6/6.. ⁵⁾	06984	210	RDS 11 ²⁾	01332
Pole-changeable, 2 speeds, three-phase current, 50 Hz, protection category IP54																
700/1435	18270/37450	1.10/4.50*	400/400	2.9/9.6*	18	471	40	120	AVD DK 900/8/4.. ¹⁾	05379	290	AVD RK 900/8/4.. ¹⁾	06995	290	PDA 12 ³⁾	05081
715/1450	22390/45410	1.80/6.50*	400/400	5.7/14.5*	24	471	40	148	AVD DK 900/8/4.. ¹⁾	05380	325	AVD RK 900/8/4.. ¹⁾	06996	325	PDA 25 ³⁾	05060
Explosion-proof, II 2G Ex h IIB + H₂ T₃ Gb, Motor Ex e, three-phase current 400 Volt, 50 Hz, protection category IP55																
700	24470	0.95*	400	2.8*	27	470	40	110	AVD DK 900/8 Ex/..	05386	180	AVD RK 900/8 Ex/..	06899	180	not permitted	
725	28470	1.3*	400	3.9*	34	470	40	130	AVD DK 900/8 Ex/..	05387	210	AVD RK 900/8 Ex/..	06900	210	not permitted	
950	30550	1.90*	400	4.7*	25	470	40	135	AVD DK 900/6 Ex/..	05389	210	AVD RK 900/6 Ex/..	06901	210	not permitted	
960	38040	3.50*	400/690	7.4*	35	498	40	160	AVD DK 900/6 Ex/..	05390	290	AVD RK 900/6 Ex/..	06902	290	not permitted	
1450	46630	6.80*	400/690	13.6*	25	498	40	175	AVD DK 900/4 Ex/..	05392	325	AVD RK 900/4 Ex/..	06903	325	not permitted	
1465	55240	10.00*	400/690	19.8*	32	498	40	235	AVD DK 900/4 Ex/..	05393	385	AVD RK 900/4 Ex/..	06904	385	not permitted	

* Motor ratings, see information p. 20. ¹⁾ Dahlander winding. ²⁾ Incl motor protection circuit breaker. ³⁾ Flush-m. version see Switch product page.
⁴⁾ and ⁵⁾ Motor protection devices, see description "Motor protection".

Performance curves 900/4

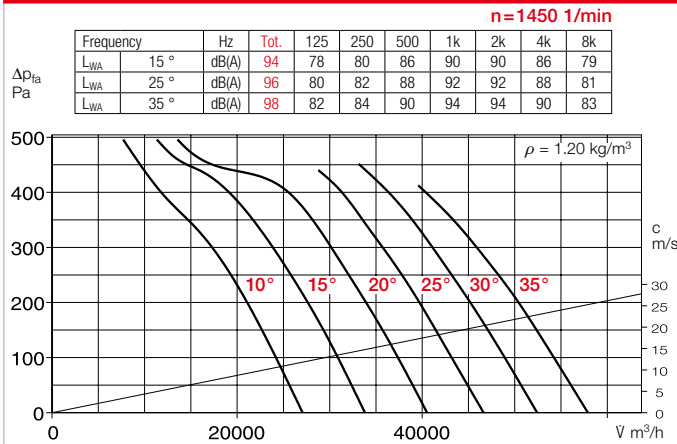

Performance curves 900/6

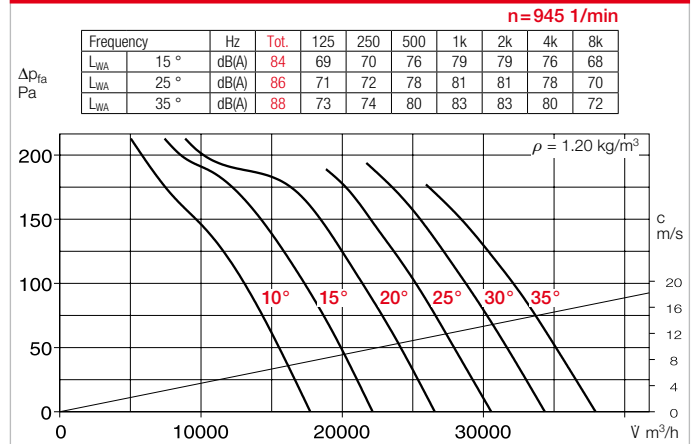

Performance curves 900/8

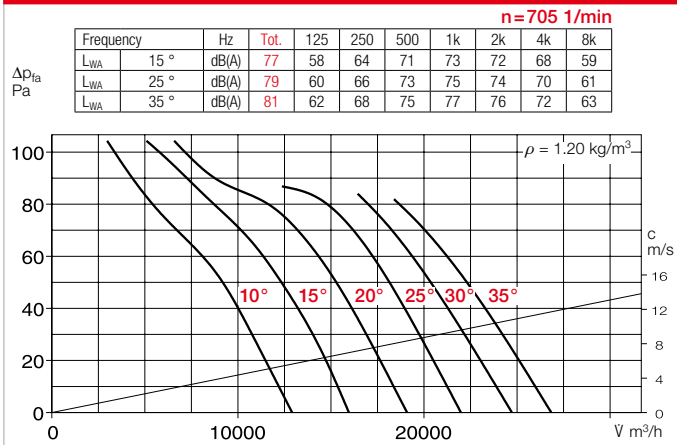

Axial and VAR fans

Accessories for AVD RK 900 Description see page 276 ff.

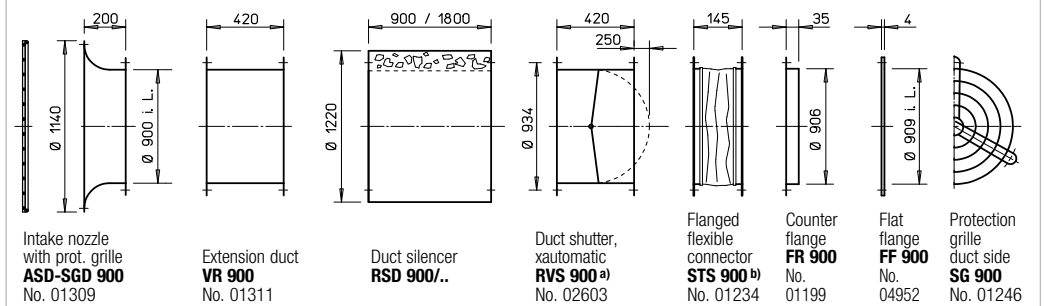

a) Shutter, motorised see Accessories product pages.

b) See below for types for explosion-proof fans.

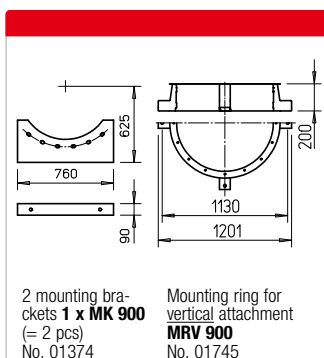

Reference	Page
Techn. description	180
Selection table	181
Planning information	14 ff.

Special design
Different voltage, protection category, air flow direction, higher air flow temperature, acid protection and impeller made of cast aluminium upon request.

Other accessories	Page
b) Access. for expl.-proof fans	
Flanged flexible connector STS 900 Ex	Ref. no. 02512
Silencers	494 ff.
Shutters and ventilation grilles	561 ff.
Speed controllers, controllers and switches	599 ff.

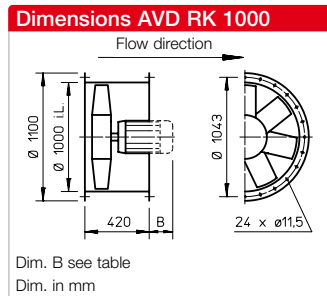
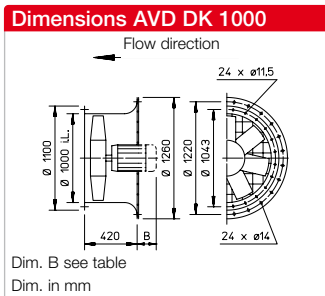

Description for all types

- **Casing**
 With motor mount made of galvanized with motor sheet.
- **Impeller**
 High performance characteristics with profiled blades made of plastic, dynamically balanced. Different for explosion-proof types.
- **Angle of attack**
 The impeller blades can be adjusted for optimal operating point coverage (except for explosion-proof types). The angle of attack is adjusted (according to the order) and fixed at the factory. The motor is assigned using the maximum power according to the information in the table below. The specified angle of attack must not be exceeded.

- **Drive**
 Closed design type IP55 or IP54. Maintenance-free and radio interference-free. Tropicalised winding with moisture proof coating. Different for explosion-proof types.
- **Motor protection**
 All types (except for pole-changeable and explosion-proof types, see page 180) are equipped with thermal contacts or PTC thermistors and must be protected by means of the following motor protection devices according to the footnotes the table:
⁴⁾MSA, Ref. no. 01289 (for PTC thermistor temperature sensor)
⁵⁾M 4, Ref. no. 01571
 All other types must be protected by means of on-site a motor protection circuit breaker.

- **Electrical connection**
 Terminal box in protection category IP54 mounted on motor.
- **Protection grille**
 Hot-dip galvanised for AVD DK as standard in accordance with DIN EN ISO 13857.
- **Power control**
 Partly through voltage reduction, see "Transformer speed controller" column. Regulated performance performance curve upon request. Frequency inverter possible for all types (except for pole-changeable and explosion-proof types). The planned use of a frequency inverter without a sine filter should be indicated when placing the order. This requires a change of fan version and additional costs, if necessary.

- **Reverse operation**
 All types are reversible using a reverser switch. Performance reduction of approx. 1/3 in abnormal flow direction.
- **Installation**
 Installation possible in any position, but be aware of any condensate drain holes depending on usage.
- **Dimensions**
 Pole-changeable and explosion-proof types may differ from the above information. Motor lengths may vary. Take note of dim. B protrusion.
- **Noise levels**
 The sound power values over the frequency and as total levels are indicated above the performance diagrams. Different for explosion-proof types.

Speed min ⁻¹	Flow rate free blowing V m ³ /h	Rated motor power (output)* kW	Voltage V	Current consump. Rat. volt./ (control)* A	Max. position ° deg.	Wiring dia- gram No.	Max. air flow temp. + °C	Wgt net aprx.** kg	Design type				Transformer speed controller 5-step, pole changing switch			
									AVD DK incl. protection grille	Ref. no.	Dim. B Motor protr. in mm	AVD RK	Ref. no.	Dim. B Motor protr. in mm	Type	Ref. no.
Three-phase current, 50 Hz, Squirrel-cage rotor, protection category IP54																
950	39720	3.0*	400/690	6.2*	23	776	40	120	AVD DK 1000/6/.. ⁴⁾	05398	290	AVD RK 1000/6/.. ⁴⁾	05573	290	—	—
955	46320	4.0*	400/690	9.2*	29	776	40	127	AVD DK 1000/6/.. ⁴⁾	05399	325	AVD RK 1000/6/.. ⁴⁾	05574	325	—	—
955	52450	5.5*	400/690	12.4*	35	776	40	145	AVD DK 1000/6/.. ⁴⁾	05400	325	AVD RK 1000/6/.. ⁴⁾	05575	325	—	—
1470	61460	11.0*	400/690	20.0*	23	776	40	160	AVD DK 1000/4/.. ⁴⁾	05401	385	AVD RK 1000/4/.. ⁴⁾	05576	385	—	—
1470	71290	15.0*	400/690	26.0*	29	776	40	195	AVD DK 1000/4/.. ⁴⁾	05402	430	AVD RK 1000/4/.. ⁴⁾	05577	430	—	—
1475	79440	18.5*	400/690	35.0*	34	776	40	210	AVD DK 1000/4/.. ⁴⁾	05403	465	AVD RK 1000/4/.. ⁴⁾	05578	465	—	—
Pole-changeable, 2 speeds, three-phase current, 50 Hz, protection category IP54													Pole changing switch			
715/1440	27410/55210	2.2/9.0*	400/400	7.2/19.0*	20	471	40	165	AVD DK 1000/8/4.. ¹⁾	05407	385	AVD RK 1000/8/4/.. ¹⁾	05582	385	PDA 25 ³⁾	05060
715/1445	32325/65330	3.0/12.0*	400/400	9.4/25.0*	26	471	40	190	AVD DK 1000/8/4.. ¹⁾	05408	415	AVD RK 1000/8/4/.. ¹⁾	05583	415	PDA 63 ³⁾	01283
Explosion-proof, II 2G Ex h IIB + H₂, T3 Gb, Motor Ex e, three-phase current 400 Volt, 50 Hz, protection category IP55																
955	43180	3.5*	400/690	7.4*	26	498	40	130	AVD DK 1000/6 Ex/..	05415	325	AVD RK 1000/6 Ex/..	05590	325	not permitted	—
960	52730	6.6*	400/690	13.4*	35	498	40	155	AVD DK 1000/6 Ex/..	05416	400	AVD RK 1000/6 Ex/..	05591	400	not permitted	—

* Motor ratings, see information p. 20. ¹⁾ Dahlander winding. ²⁾ Incl motor protection circuit breaker. ³⁾ Flush-m. version see Switch product page.
⁴⁾ and ⁵⁾ Motor protection devices, see description "Motor protection".

Performance curves 1000/4

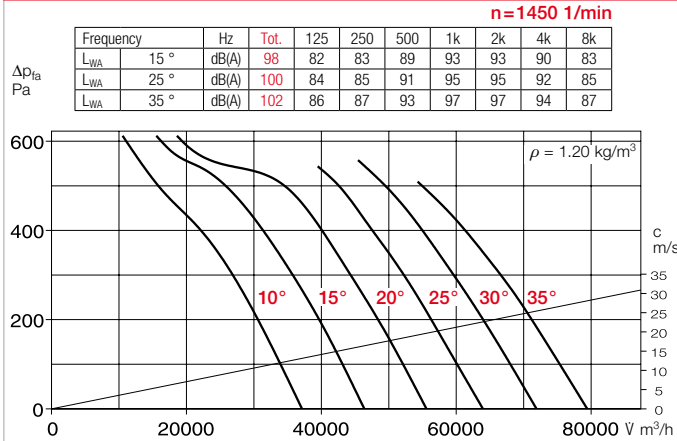

Performance curves 1000/6

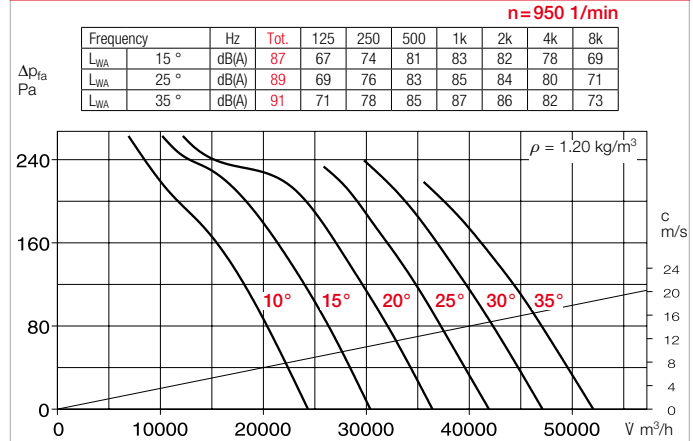

Performance curves 1000/8

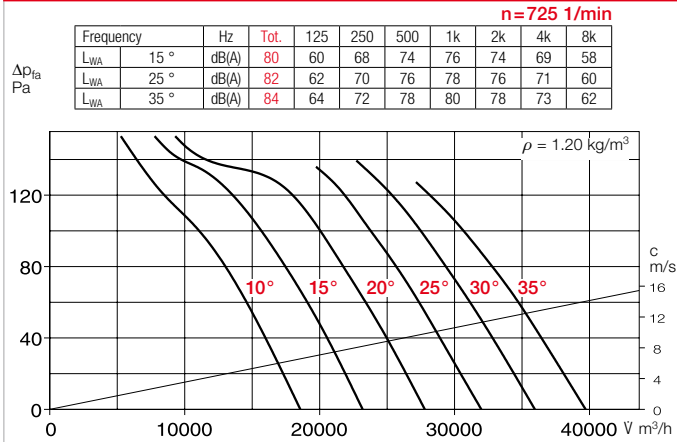

Accessories for AVD RK 1000 Description see page 276 ff.

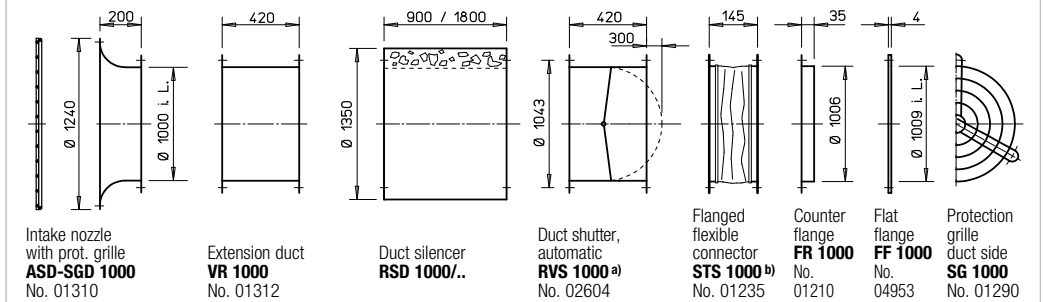

^{a)} Shutter, motorised see Accessories product pages.

^{b)} See below for types for explosion-proof fans.

Elec. speed controller, continuously variable Frequency inverter with sine filter		Vibration damper Nominal size	
Type	Ref. no.	Type	Ref. no.
		SDD/SDZ	
FU-BS 8.0²⁾	05461	..2/..2	01453/01455
FU-BS 10.0²⁾	05462	..2/..2	01453/01455
FU-BS 10.0²⁾	05462	..2/..2	01453/01455
FU-CS 22²⁾	05470	..3/..3	01367/01366
FU-CS 32²⁾	05471	..3/..3	01367/01366
FU-CS 40²⁾	05472	..3/..3	01367/01366
—	—	..3/..3	01367/01366
—	—	..3/..3	01367/01366
not permitted	—	..2/..2	01453/01455
not permitted	—	..2/..2	01453/01455

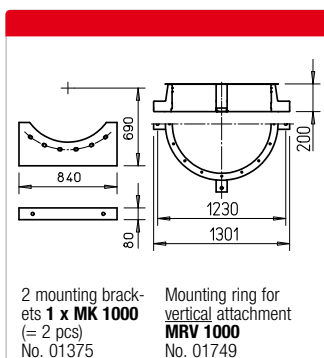

Reference	Page
Techn. description	180
Selection table	181
Planning information	14 ff.
Special design	
Different voltage, protection category, air flow direction, higher air flow temperature, acid protection and impeller made of cast aluminium upon request.	

Other accessories	Page
^{b)} Access. for expl.-proof fans	
Flanged flexible connector STS 1000 Ex	Ref. no. 02513
Silencers	494 ff.
Shutters and ventilation grilles	561 ff.
Speed controllers, controllers and switches	599 ff.